

SKV 260 appendix 2
KU XML-structure income year 2019

Version 5.0

SKV 260 appendix 2	Version: 5.0
XML-struktur	2019-02-21

Index

INDEX	2
SUMMARY	8
1 DOCUMENT INFORMATION	8
1.1 TARGET GROUP	8
1.2 TERMS AND DEFINITIONS.....	8
1.3 REFERENCES	8
2 TABLE DESCRIPTION	9
3 GENERAL INFORMATION	10
3.1 VALIDATION AGAINST XML-SCHEMA.....	10
3.2 CHARACTER SET.....	10
3.3 SUFFIX.....	10
4 OVERALL HIERARCHY	11
4.1 SKATTEVERKET – INCOME STATEMENTS	11
5 COMMON FILE INFORMATION	12
5.1 AVSANDARE (SENDER).....	12
5.1.1 <i>Teknisk kontaktperson (Technical contact person)</i>	12
5.2 BLANKETTGENSAMT (COMMON FORMS CONTENT).....	13
5.2.1 <i>Uppgiftslamnare (Information provider)</i>	13
5.2.1.1 Kontaktperson (Contact person).....	14
6 FORM ENTRIES	15
6.1 CASE INFORMATION	15
6.2 INCOME STATEMENT FORMS	15
6.2.1 <i>KU10 – Income statement from employers, etc.</i>	18
6.2.1.1 Element: InkomsttagareKU10.....	23
6.2.1.2 Element: UppgiftslamnareKU10.....	25

SKV 260 appendix 2	Version: 5.0
XML-struktur	2019-02-21

6.2.1.3	Changes compared to income year 2018 in KU10.....	26
6.2.2	<i>KU13 – Special income tax for non-residents (SINK)</i>	28
6.2.2.1	Element: InkomsttagareKU13	31
6.2.2.2	Element: UppgiftslamnareKU13	33
6.2.2.3	Changes compared to income year 2018 in KU13.....	33
6.2.3	<i>KU14 – Pensionable income and exchange of income statements</i>	35
6.2.3.1	Element: InkomsttagareKU14.....	39
6.2.3.2	Element: UppgiftslamnareKU14.....	41
6.2.3.3	Changes compared to income year 2018 in KU14.....	41
6.2.4	<i>KU16 – Statements regarding maritime income, etc.</i>	43
6.2.4.1	Element: InkomsttagareKU16.....	46
6.2.4.2	Element: UppgiftslamnareKU16.....	48
6.2.4.3	Changes compared to income year 2018 in KU16.....	48
6.2.5	<i>KU17 – Special income statement – Special income tax (for non-residents, SINK) for foreign residents with maritime income</i>	49
6.2.5.1	Element: InkomsttagareKU17.....	52
6.2.5.2	Element: UppgiftslamnareKU17.....	54
6.2.5.3	Changes compared to income year 2018 in KU17.....	54
6.2.6	<i>KU18 – Income statement from the pension and insurance payer etc.</i>	56
6.2.6.1	Element: InkomsttagareKU18.....	58
6.2.6.2	Element: UppgiftslamnareKU18.....	60
6.2.6.3	Changes compared to income year 2018 in KU18.....	60
6.2.7	<i>KU19 – Income statement special income tax for non-residents (SINK) from the pension and insurance payer</i>	61
6.2.7.1	Element: InkomsttagareKU19.....	63
6.2.7.2	Element: UppgiftslamnareKU19.....	65
6.2.7.3	Changes compared to income year 2018 in KU19.....	66
6.2.8	<i>KU20 – Income statement for interest income</i>	67
6.2.8.1	Element: InkomsttagareKU20.....	69
6.2.8.2	Element: UppgiftslamnareKU20.....	71
6.2.8.3	Changes compared to income year 2018 in KU20.....	72
6.2.9	<i>KU21 – Income statement for bonds</i>	73
6.2.9.1	Element: InkomsttagareKU21.....	75
6.2.9.2	Element: UppgiftslamnareKU21.....	77

SKV 260 appendix 2	Version: 5.0
XML-struktur	2019-02-21

6.2.9.3	Changes compared to income year 2018 in KU21.....	78
6.2.10	<i>KU25 – Income statement for interest expense</i>	79
6.2.10.1	Element: InkomsttagareKU25.....	81
6.2.10.2	Element: UppgiftslamnareKU25.....	83
6.2.10.3	Changes compared to income year 2018 in KU25.....	83
6.2.11	<i>KU26 – Income statement for site leasehold fees</i>	84
6.2.11.1	Element: InkomsttagareKU26.....	85
6.2.11.2	Element: UppgiftslamnareKU26.....	87
6.2.11.3	Changes compared to income year 2018 in KU26.....	87
6.2.12	<i>KU28 – Income statement for private investors tax relief</i>	88
6.2.12.1	Element: InkomsttagareKU28.....	90
6.2.12.2	Element: UppgiftslamnareKU28.....	92
6.2.12.3	Changes compared to income year 2018 in KU28.....	92
6.2.13	<i>KU30 – Income statement for investment savings account – standard income</i>	93
6.2.13.1	Element: InkomsttagareKU30.....	94
6.2.13.2	Element: UppgiftslamnareKU30.....	96
6.2.13.3	Changes compared to income year 2018 in KU30.....	96
6.2.14	<i>KU31 – Income statement for dividends etc for shares and other securities</i>	97
6.2.14.1	Element: InkomsttagareKU31.....	100
6.2.14.2	Element: UppgiftslamnareKU31.....	102
6.2.14.3	Changes compared to income year 2018 in KU31.....	103
6.2.15	<i>KU32 – Income statement for transfer of shares, bonds and other securities</i>	104
6.2.15.1	Element: InkomsttagareKU32.....	106
6.2.15.2	Element: UppgiftslamnareKU32.....	108
6.2.15.3	Changes compared to income year 2018 in KU32.....	108
6.2.16	<i>KU34 – Income statement for the transfer/issuance/completion of options</i>	109
6.2.16.1	Element: InkomsttagareKU34.....	111
6.2.16.2	Element: UppgiftslamnareKU34.....	113
6.2.16.3	Changes compared to income year 2018 in KU34.....	113
6.2.17	<i>KU35 – Income statement for completion of futures</i>	114
6.2.17.1	Element: InkomsttagareKU35.....	116
6.2.17.2	Element: UppgiftslamnareKU35.....	118

SKV 260 appendix 2	Version: 5.0
XML-struktur	2019-02-21

6.2.17.3	Changes compared to income year 2018 in KU35.....	118
6.2.18	<i>KU40 – Income statement for transfer of shares in investment funds</i>	<i>119</i>
6.2.18.1	Element: InkomsttagareKU40.....	121
6.2.18.2	Element: UppgiftslamnareKU40.....	123
6.2.18.3	Changes compared to income year 2018 in KU40.....	124
6.2.19	<i>KU41 – Income statement – Investment fund – standard income</i>	<i>124</i>
6.2.19.1	Element: InkomsttagareKU41	126
6.2.19.2	Element: UppgiftslamnareKU41	128
6.2.19.3	Changes compared to income year 2018 in KU41	129
6.2.20	<i>KU50 – Income statement for pension savings</i>	<i>130</i>
6.2.20.1	Element: InkomsttagareKU50.....	132
6.2.20.2	Element: UppgiftslamnareKU50.....	134
6.2.20.3	Changes compared to income year 2018 in KU50.....	135
6.2.21	<i>KU52 – Income statement for foreign insurance</i>	<i>136</i>
6.2.21.1	Element: InkomsttagareKU52.....	138
6.2.21.2	Element: UppgiftslamnareKU52.....	140
6.2.21.3	Changes compared to income year 2018 in KU52.....	141
6.2.22	<i>KU53 – Income statement regarding indirect insurance</i>	<i>142</i>
6.2.22.1	Element: InkomsttagareKU53	144
6.2.22.2	Element: UppgiftslamnareKU53.....	146
6.2.22.3	Changes compared to income year 2018 in KU53.....	146
6.2.23	<i>KU55 – Income statement regarding transfer of tenant-ownership in a housing association</i>	<i>147</i>
6.2.23.1	Element: InkomsttagareKU55	150
6.2.23.2	Element: UppgiftslamnareKU55.....	151
6.2.23.3	Changes compared to income year 2018 in KU55.....	151
6.2.24	<i>KU65 – Income statement donation</i>	<i>152</i>
6.2.24.1	Element: InkomsttagareKU65.....	153
6.2.24.2	Element: UppgiftslamnareKU65.....	155
6.2.24.3	Changes compared to income year 2018 in KU65.....	155
6.2.25	<i>KU66 – Renewable electricity.....</i>	<i>156</i>
6.2.25.1	Element: InkomsttagareKU66.....	158
6.2.25.2	Element: UppgiftslamnareKU66.....	160

SKV 260 appendix 2	Version: 5.0
XML-struktur	2019-02-21

6.2.25.3	Changes compared to income year 2018 in KU66.....	160
6.2.26.3	Changes compared to income year 2018 in KU67.....	164
6.2.27	<i>KU70 – Income statement regarding operating subsidies and royalties.....</i>	<i>165</i>
6.2.27.1	Element: InkomsttagareKU70.....	166
6.2.27.2	Element: UppgiftslamnareKU70.....	168
6.2.27.3	Changes compared to income year 2018 in KU70.....	168
6.2.28	<i>KU71 – Income statement regardig withdrawal from forest account, etc.</i>	<i>169</i>
6.2.28.1	Element: InkomsttagareKU71.....	171
6.2.28.2	Element: UppgiftslamnareKU71.....	173
6.2.28.3	Changes compared to income year 2018 in KU71.....	173
6.2.29	<i>KU72 – Income statement regarding deposit in forest account, etc.</i>	<i>174</i>
6.2.29.1	Element: InkomsttagareKU72.....	176
6.2.29.2	Element: UppgiftslamnareKU72.....	178
6.2.29.3	Changes compared to income year 2018 in KU72.....	179
6.2.30	<i>KU73 – Income statement regarding dividends etc. for share-holders in an association.....</i>	<i>180</i>
6.2.30.1	Element: InkomsttagareKU73.....	182
6.2.30.2	Element: UppgiftslamnareKU73.....	184
6.2.30.3	Changes compared to income year 2018 in KU73.....	184
6.2.31	<i>KU80 – Income statement regarding foreign payments to Sweden.....</i>	<i>185</i>
6.2.31.1	Element: InkomsttagareKU80.....	186
6.2.31.2	Element: UppgiftslamnareKU80.....	187
6.2.31.3	Changes compared to income year 2018 in KU80.....	188
6.2.32	<i>KU81 – Income statement regarding foreign payments from Sweden.....</i>	<i>189</i>
6.2.32.1	Element: InkomsttagareKU81.....	191
6.2.32.2	Element: UppgiftslamnareKU81.....	192
6.2.32.3	Changes compared to income year 2018 in KU81.....	193
6.2.33	<i>KupongS – Accounting, Swedish withholding tax in VPC-registered/-affiliated companies.....</i>	<i>194</i>
6.2.33.1	UppgiftslamnareKupongS.....	198
6.2.33.2	Changes compared to income year 2018 in KupongS.....	198
7	ATTRIBUTES.....	199
7.1	ATTRIBUTE ”OMRADE” IN ELEMENT ”SKATTEVERKET”.....	199

SKV 260 appendix 2	Version: 5.0
XML-struktur	2019-02-21

THE ATTRIBUTE IS COMPULSORY AND SHOULD BE SET TO “KONTROLLUPPGIFTER” 199

7.2 ATTRIBUTE ”NUMMER” IN ELEMENT ”BLANKETT” 199

7.3 ATTRIBUTE “FALTKOD” IN VARIOUS DATA ELEMENTS 200

SKV 260 appendix 2	Version: 5.0
XML-struktur	2019-02-21

Summary

This document describes the XML format used for electronic filing of income statements.

1 Document information

1.1 Target group

This document is intended for software companies and information providers using their own systems to generate income statement files.

The technical description is available only at the Skatteverket web site (ref[2]); it is not available in print.

1.2 Terms and definitions

XML = eXtensible Markup Language. A standard for structured text based representation of information.

XML Schema = A set of rules describing permitted syntax and grammar in an XML document. A schema file has the suffix .xsd.

Parse = Divide a text into parts and interpret their meaning.

Meta data = Data about data, that is, a description or statement about a piece of data.

1.3 References

Ref	Title	Editor	Address
[1]	XML schema for income statement files	Skatteverket	http://www.skatteverket.se/foretagochorganisationer/sjalvservice/allaetjanster/schemalagerxml/filoverforingkontrolluppgifter.4.15532c7b1442f256bae13265.html
[2]	Technical description and test service at the Skatteverket web site	Skatteverket	http://www.skatteverket.se/foretagochorganisationer/arbetsgivare/lamnakontrolluppgifter/testtjanstochtekniskbeskrivning.4.233f91f71260075abe8800073614.html

SKV 260 appendix 2	Version: 5.0
XML-struktur	2019-02-21

2 Table description

This document describes the terms included in the electronic filing of income statements.

The XML schema (ref[1], including the XML string, are based on the details in this description.

Explanation of the columns in the following tables:

- Term/Field
 - Description: Description or field name from the corresponding form.
 - Code: Field code in applicable cases.
- Element name in XML: The element found in the XML schema.
- No.: Number of occurrences of the current group/term in the enclosing group. The following variants occur:
 - 0-1: Zero or one occurrence, i.e., the group/term is not compulsory. Marked "minOccurs="0"" in the schema. The description column specifies when the group/term should and should not be notified.
 - 1: One occurrence, i.e., the group/term is compulsory. No marking the schema (default).
 - 0-n: Zero or more occurrences. Applies only to groups. Marked "minOccurs="0" maxOccurs="unbounded"" in the schema.
 - 1-n: One or more occurrences. Applies only to groups. Marked "maxOccurs="unbounded"" in the schema.
- Type: Specifies if it is a group ("Grp") or a term with a reference to the value store (Appendix 1).
- Controls
 - ID: Identification label applied to the control.
 - Description: Textual description of the control.
- Color coding:

Group element

SKV 260 appendix 2	Version: 5.0
XML-struktur	2019-02-21

3 General information

3.1 Validation against XML-schema

Generated XML files can be validated against an XML schema published in accordance with ref [1]. Skatteverket's schema layer is a common storage area which facilitates reuse and access of Skatteverket's public XML schemas. The schema is structured in the following way:

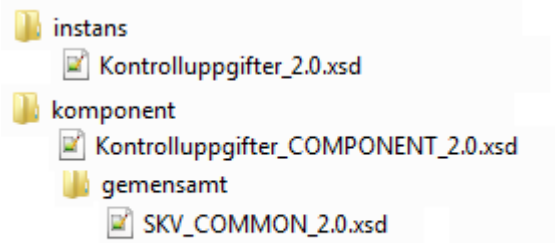

3.2 Character set

Skatteverket supports the UTF-8 character set for income statement files (8-bit Unicode transformation format).

3.3 Suffix

It has been mandatory in previous versions of the XML-files to use a suffix (only the suffix “ku:” until recently). This is, from schema version 2.0 and onward, not necessary. Files using a (any) suffix and files using no suffix will pass our validation. The header must state the suffix used or if the file is not using suffix. How this can be done is shown in appendix 4, Example files.

SKV 260 appendix 2	Version: 5.0
XML-struktur	2019-02-21

4 Overall hierarchy

The following diagram illustrates the overall hierarchy of electronic filing of income statements. The attribute “omrade” of the root element “Skatteverket” should be set to ”Kontrolluppgifter”.

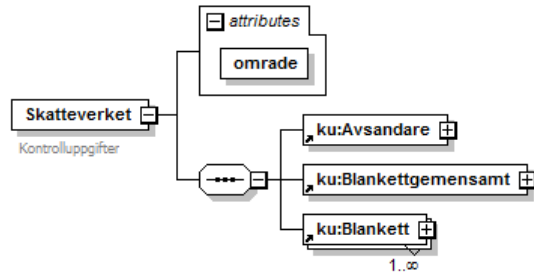

4.1 Skatteverket – Income statements

Term/Field		Element name in XML	No.	Type	Controls	
Description	Code				ID	Description
Skatteverket, root element. Compulsory Attribute: omrade="Kontrolluppgifter"		Skatteverket	1	Grp		
Information of sender		Avsandare	1	Grp		
Form information shared by all forms included in the file		Blankettgemensamt	1	Grp		
Forms content and case information		Blankett	1-n	Grp		

SKV 260 appendix 2	Version: 5.0
XML-struktur	2019-02-21

5 Common file information

This section illustrates the hierarchy of the information common to all forms in the file.

5.1 Avsändare (Sender)

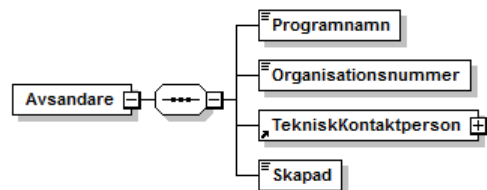

Term/Field					Controls	
Description	Code	Element name in XML	No.	Type	ID	Description
Software name used to produce the file		Programnamn	1	Text50		
File producers Identification number.		Organisationsnummer	1	Identitet		
Information of technical contact person at the file producer		TekniskKontaktperson	1	Grp		
Time the file was created.		Skapad	1	Skapad		

5.1.1 Teknisk kontaktperson (Technical contact person)

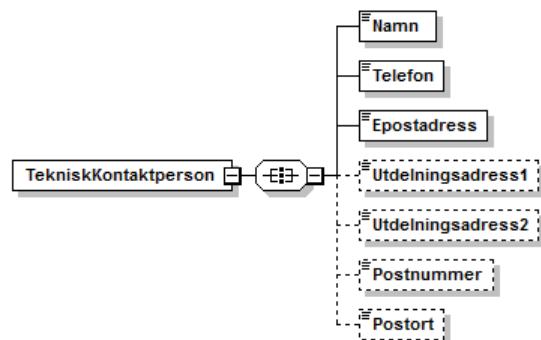

SKV 260 appendix 2	Version: 5.0
XML-struktur	2019-02-21

Term/Field Description	Code	Element name in XML	No.	Type	Controls	
					ID	Description
Technical contact persons name		Namn	1	Text50		
Technical contact persons phone number		Telefon	1	Text20		
Technical contact persons email (receipt on file via eTransport is sent here)		Epostadress	1	Epost		
Senders address 1		Utdelningsadress1	0-1	Text50		
Senders address 2		Utdelningsadress2	0-1	Text50		
Senders Postal code		Postnummer	0-1	PostNummer		
Senders postal location		Postort	0-1	Text30		

5.2 Blankettgemensamt (Common forms content)

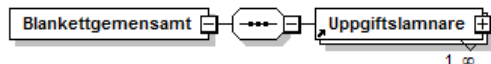

Term/Field Description	Code	Element name in XML	No.	Type	Controls	
					ID	Description
All information providers existing in the file.		Uppgiftslamnare	1-n	Grp		

5.2.1 Uppgiftslamnare (Information provider)

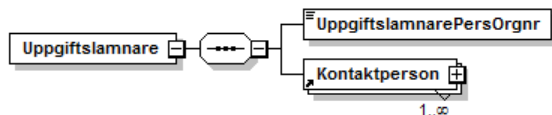

Term/Field Description	Code	Element name in XML	No.	Type	Controls	
					ID	Description
Identification of information provider. More than one can exist.		UppgiftslamnarePersOrgnr	1	Identitet		

SKV 260 appendix 2	Version: 5.0
XML-struktur	2019-02-21

Term/Field Description	Code	Element name in XML	No.	Type	Controls	
					ID	Description
Information providers contact person		Kontaktperson	1-n	Grp		

5.2.1.1 Kontaktperson (Contact person)

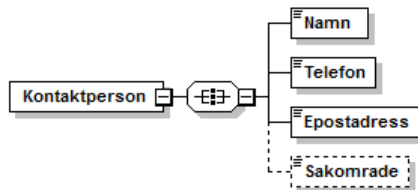

Term/Field Description	Code	Element name in XML	No.	Type	Controls	
					ID	Description
Contact persons name		Namn	1	Text50		
Contact persons phone number		Telefon	1	Text20		
Contact persons e-mail		Epostadress	1	Epost		
Area of expertise for contact person		Sakomrade	0-1	Text50		

SKV 260 appendix 2	Version: 5.0
XML-struktur	2019-02-21

6 Form entries

The file can contain one or more form entries. The form element can have an attribute where the Skatteverket form number (SKV number) is entered in the area for income statements. For more information, see the Skatteverket web site (ref[2]), or chapter 7 in this document. The following diagram illustrates the hierarchy of the form entries.

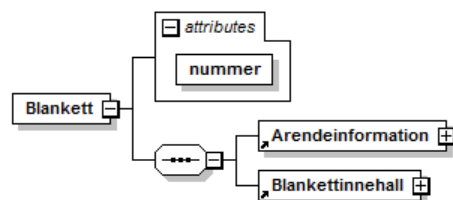

6.1 Case information

The table column “Description” specifies how the elements should be applied for the income statements area.

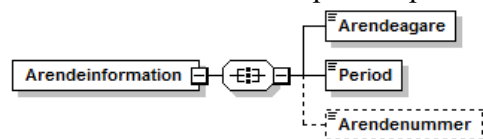

Term/Field Description	Code	Element name in XML	No.	Type	Controls	
					ID	Description
Equal to information providers Id number (UppgiftslamnarId) from the form element		Arendeagare	1	Identitet		
Equal to income year (Inkomstar) from the form element		Period	1	Text20		
Skatteverkets case number (do not use for income statements)		Arendenummer	0-1	Text13		

6.2 Income statement forms

The element has an abstract subgroup called “Kontrolluppgift” that is exchanged for any of the different income statements types described in the following chapter. Certain elements require the fixed attribute “faltkod”. Information about which field code corresponds to which element is found in the table of each form type, and also in chapter 7 in this document.

SKV 260 appendix 2	Version: 5.0
XML-struktur	2019-02-21

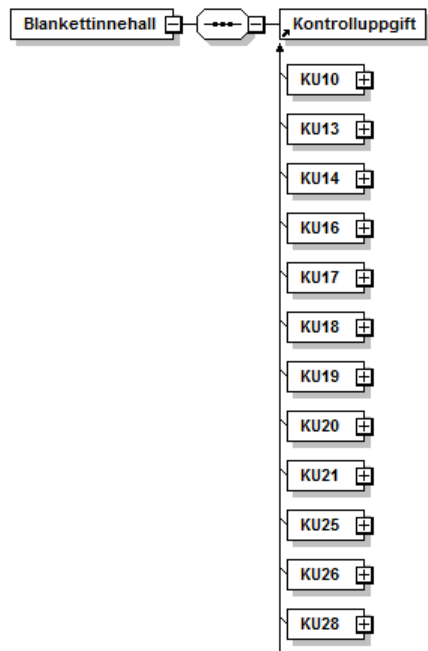

SKV 260 appendix 2	Version: 5.0
XML-struktur	2019-02-21

- KU30
- KU31
- KU32
- KU34
- KU35
- KU40
- KU41
- KU50
- KU52
- KU53
- KU55
- KU65
- KU66
- KU67
- KU70
- KU71
- KU72
- KU73
- KU80
- KU81
- KupongS

SKV 260 appendix 2	Version: 5.0
XML-struktur	2019-02-21

6.2.1 KU10 – Income statement from employers, etc.

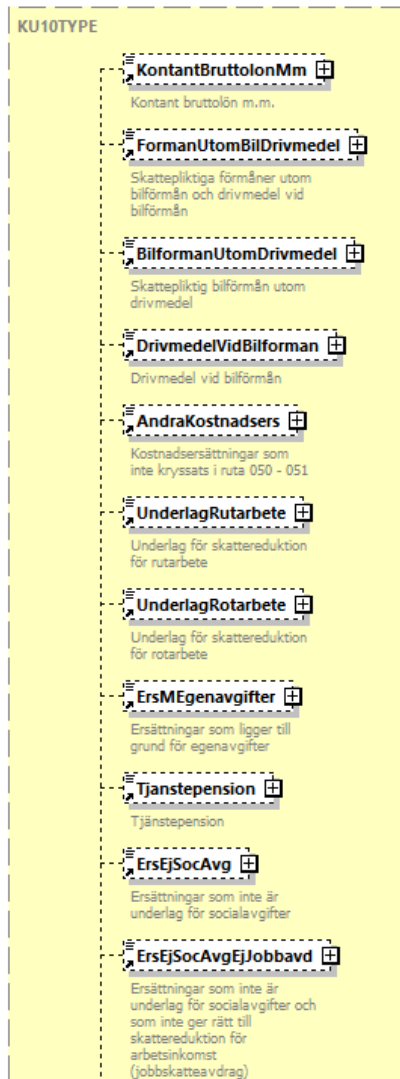

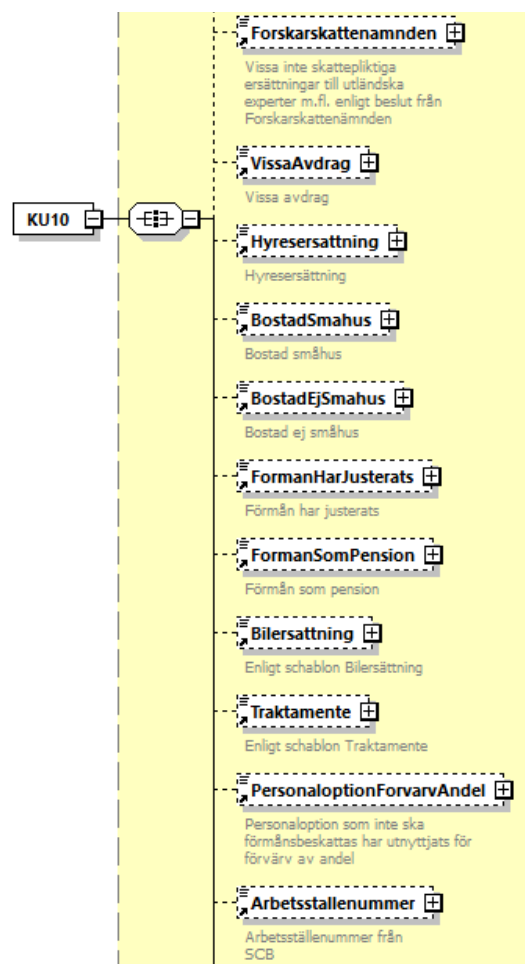

SKV 260 appendix 2	Version: 5.0
XML-struktur	2019-02-21

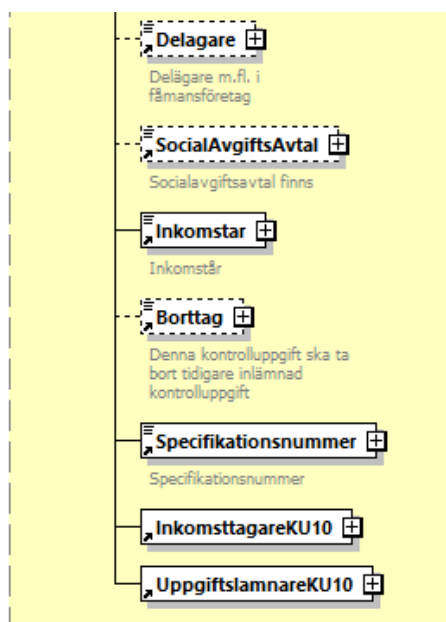

Term/Field					Controls	
Description	Code	Element name in XML	No.	Type	ID	Description
Cash gross income etc.	011	KontantBruttolonMm	0-1	Belopp10	010, 183	Fk011 must exist if Fk205, Fk012, Fk013, Fk020, Fk025, Fk030-035, Fk039 and Fk050-051 are all missing. Fk011 cannot exist if Fk093 is missing.
Taxable benefits excl.employer-provided car and free fuel in connection with employer-provided car	012	FormanUtomBilDrivmedel	0-1	Belopp10	015, 017, 184	If one or more of Fk041 and Fk043 exists and Fk031 and Fk025 are missing: Fk012 >= 0. Fk012 or Fk031 or Fk025 must exist if Fk021 or Fk022 exists. Fk012 cannot exist if Fk093 is missing.
Taxable benefit of employer-provided car exclusive of fuel	013	BilformanUtomDrivmedel	0-1	Belopp7	185	Fk013 cannot exist if Fk093 is missing.
Free fuel in connection with employer-provided car	018	DrivmedelVidBilforman	0-1	Belopp7	186	Fk018 cannot exist if Fk093 is missing.
Compensation for expenses that has not been ticked in the box 050	020	AndraKostnadsers	0-1	Belopp7		

SKV 260 appendix 2	Version: 5.0
XML-struktur	2019-02-21

Term/Field Description	Code	Element name in XML	No.	Type	Controls	
					ID	Description
Basis for tax reduction for household services	021	UnderlagRutarbete	0-1	Belopp7		
Basis for tax reduction for "ROT-work"	022	UnderlagRotarbete	0-1	Belopp7		
Remuneration for which the employee pays social security contributions	025	ErsMEgenavgifter	0-1	Belopp10	139	Fk25 cannot exist if Fk93 exists
Occupational pension	030	Tjanstepension	0-1	Belopp10		
Remunerations for which social security contributions are not paid	031	ErsEjSocAvg	0-1	Belopp10		
Remunerations for which social security contributions are not paid and which are not entitled to special job deduction	032	ErsEjSocAvgEjJobbavd	0-1	Belopp10		
Not taxable remunerations to foreign key persons etc.	035	Forskarskattenamnden	0-1	Belopp10		
Certain deductions	037	VissaAvdrag	0-1	Belopp6		
Rent	039	Hysesersattning	0-1	Belopp7		
Free housing 1- or 2-family house	041	BostadSmahus	0-1	Kryss		
Free housing other than code 41	043	BostadEjSmahus	0-1	Kryss		
Benefit has been adjusted	048	FormanHarJusterats	0-1	Kryss	038	If Fk048 exists and Fk031 and Fk025 are missing, then Fk012 or Fk013 must exist.
Benefit as pension	049	FormanSomPension	0-1	Kryss	040	If Fk049 exists, then Fk012 or Fk013 must exist.
Car allowance	050	Bilersattning	0-1	Kryss		
Per diem	051	Traktamente	0-1	Kryss		
Employee options that are not subject to preferential taxation have been utilized for acquisition of shares	059	PersonalooptionForvarvAndel	0-1	Kryss		
Number for work location from SCB	060	Arbetsstallenummer	0-1	ArbetsstalleNummer		
Partner etc., companies consisting of few employees	061	Delagare	0-1	Kryss		
Specification of other benefits at code 047	065	SpecAvAnnanForman	0-1	Text40	041	FK065 must exist if FK047 exists
Specification of amount at code 037	070	SpecVissaAvdrag	0-1	Text40	042	FK070 must exist if FK037 exists

SKV 260 appendix 2	Version: 5.0
XML-struktur	2019-02-21

Term/Field		Element name in XML	No.	Type	Controls	
Description	Code				ID	Description
Social security agreement exists	093	SocialAvgiftsAvtal	0-1	Kryss		
Income year	203	Inkomstar	1	Inkomstar	163	Fk203 must be equal to Period
Removal	205	Borttag	0-1	Kryss	055	FK205 can only exist if all codes except Fk201, Fk203, Fk570, Fk215, Fk222 and Fk224 are missing.
Specification number	570	Specifikationsnummer	1	SpecifikationsN ummer		
Income earner		InkomsttagareKU10	1	Grp		
Information provider		UppgiftslamnareKU10	1	Grp		

SKV 260 appendix 2	Version: 5.0
XML-struktur	2019-02-21

6.2.1.1 Element: InkomstagareKU10

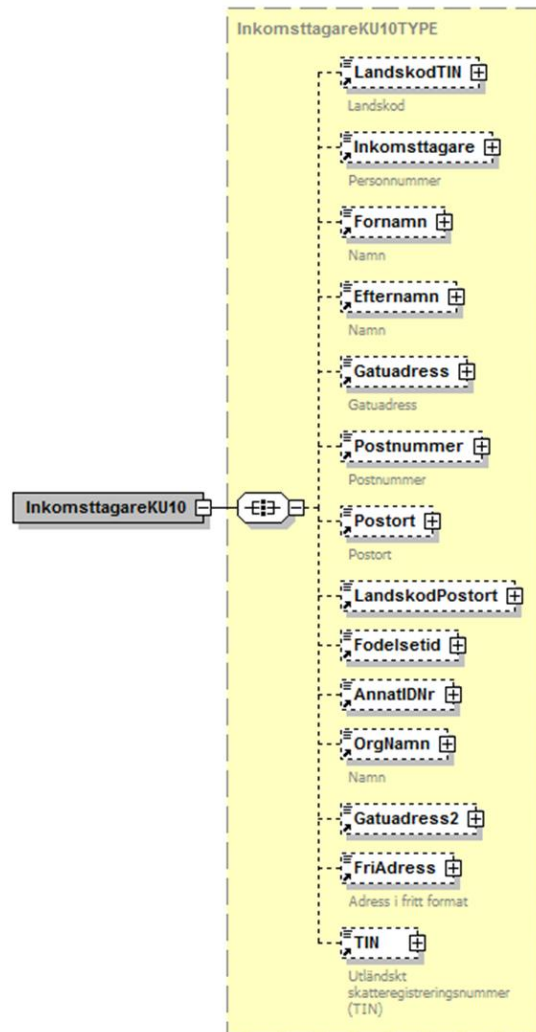

SKV 260 appendix 2	Version: 5.0
XML-struktur	2019-02-21

Term/Field		Element name in XML	No.	Type	Controls	
Description	Code				ID	Description
Personal identity number	215	Inkomsttagare	0-1	Identitet	056, 173	Fk215 must exist if Fk222 and Fk224 are missing. Fk215 can not start with 16 if Fk011, Fk012, Fk013 or Fk025 has value >0
Country code TIN	076	Landskod TIN	0-1	Landskod	045	FK076 must exist if FK252 exists
Personal identity number/ Co-ordination number	215	Inkomsttagare	0-1	Identitet	056, 173	FK215 must exist if FK222 and FK224 is missing. FK215 cannot begin with 16 if FK011,FK012,FK013 or FK025 is >0.
Person's first name	216	Fornamn	0-1	Text50	057, 142	FK216 must exist if FK222 exists and FK 205 is missing FK216 must exist if FK215 has the value CCYY > 1800 and DD > 60 and Fk205 is missing
Person's last name	217	Efternamn	0-1	Text50	058, 143	FK217 must exist if FK222 exists and FK 205 is missing FK217 must exist if FK215 has the value CCYY > 1800 and DD > 60 and Fk205 is missing
Person's address	218	Gatuadress	0-1	Text50	059, 144, 152	FK218 must exist if FK222 exists and FK205 and FK230 is missing FK218 must exist if FK215 has the value CCYY > 1800 and DD > 60 and Fk205 and FK230 is missing FK218 must exist if FK224 exists and FK205 and FK215 and FK222 and FK230 is missing
Person's address contiuing	228	Gatuadress2	0-1	Text50		
Person's post number	219	Postnummer	0-1	PostNummer	060, 145, 153	FK219 must exist if FK222 exists and FK 205 and FK230 is missing FK219 must exist if FK215 has the value CCYY > 1800 and DD > 60 and Fk205 and FK230 is missing FK219 must exist if FK224 exists and FK205 and FK215 and FK222 and FK230 is missing

SKV 260 appendix 2	Version: 5.0
XML-struktur	2019-02-21

Term/Field		Element name in XML	No.	Type	Controls	
Description	Code				ID	Description
Person's postal location	220	Postort	0-1	Text50	061, 146, 154	FK220 must exist if FK222 exists and FK 205 and FK230 is missing FK220 must exist if FK215 has the value CCYY > 1800 and DD > 60 and Fk205 and FK230 is missing FK220 must exist if FK224 exists and FK205 and FK215 and FK222 and FK230 is missing
Country code for postal location	221	LandskodPostort	0-1	Landskod	166	FK221 must exist if FK230 exists
Date of birth	222	Fodelsetid	0-1	Fodelsetid	063	FK222 cannot exist if FK215 exists
Other ID number	224	AnnatIDNr	0-1	Text20		
Name of legal entity	226	OrgNamn	0-1	Text50	065, 151	FK226 cannot exist if Fk222 exists, if FK215 has CC > 17, if Fk216 exists or if Fk217 exists. FK226 must exist if FK224 exists and FK205, FK215, FK216, FK217 and FK222 is missing
Address in free format	230	FriAdress	0-1	Text350		
TIN	252	TIN	0-1	Text20	066	FK252 must exist if FK078 exists

6.2.1.2 Element: UppgiftslamnareKU10

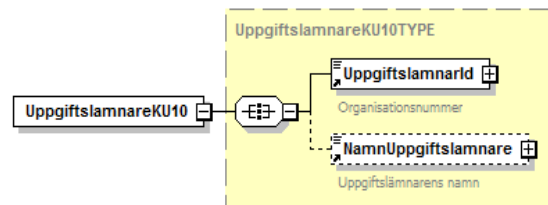

Term/Field		Element name in XML	No.	Type	Controls	
Description	Code				ID	Description
Information provider's organization number	201	UppgiftslamnarId	1	Identitet	053	FK201 cannot be equal to FK215
Information provider's name	202	NamnUppgiftslamnare	0-1	Text50		

SKV 260 appendix 2	Version: 5.0
XML-struktur	2019-02-21

6.2.1.3 Changes compared to income year 2018 in KU10

Term/Field Description	Code	Element name in XML	No.	Type	Controls		Change
					ID	Description	
Tax deducted	001	AvdragenSkatt	0-1	Belopp10			Removed field
Period of employment as from	008	AnstalldFrom	0-1	Manad			Removed field
Period of employment up to	009	AnstalldTom	0-1	Manad	009	Fk009 must be >= Fk008	Removed field
Cash gross income etc.	011	KontantBruttolonMm	0-1	Belopp10	010, 183	Fk011 must exist if Fk205, Fk012, Fk013, Fk020, Fk025, Fk030-035, Fk039 and Fk050-051 are all missing. Fk011 cannot exist if Fk093 is missing.	Changed field control Added field control
Taxable benefits excl. employer-provided car and free fuel in connection with employer-provided car	012	FormanUtomBilDrivmedel	0-1	Belopp10	015, 017, 184	If one or more of Fk041 and Fk043 exists and Fk031 and Fk025 are missing: Fk012 >= 0. Fk012 or Fk031 or Fk025 must exist if Fk021 or Fk022 exists. Fk012 cannot exist if Fk093 is missing.	Changed field control Added field control
Taxable benefit of employer-provided car exclusive of fuel	013	BilformanUtomDrivmedel	0-1	Belopp7	185	Fk013 cannot exist if Fk093 is missing.	Changed field control Added field control
Code for employer-provided car	014	KodForFormansbil	0-1	Bilkod	030	FK014 must exist if FK013 exists	Removed field
Number of months with employer-provided car	015	AntalManBilforman	0-1	AntalManader			Removed field
Number of kilometers with car allowance for employer-provided car	016	KmBilersVidBilforman	0-1	AntalKm			Removed field
Employee's payment for employer-provided car	017	BetaltForBilforman	0-1	Belopp7			Removed field
Free fuel in connection with employer-provided car	018	DrivmedelVidBilforman	0-1	Belopp7	186	Fk018 cannot exist if Fk093 is missing.	Added field control
Compensation for expenses that has not been ticked in the box 050	020	AndraKostnadsers	0-1	Belopp7			New term/field description
Certain deductions	037	VissaAvdrag	0-1	Belopp6			Removed field control
Free housing 1- or 2-family house	041	BostadSmahus	0-1	Kryss			Removed field control
Free meals	042	Kost	0-1	Kryss			Removed field
Interest	044	Ranta	0-1	Kryss			Removed field
Free parking	045	Parkering	0-1	Kryss			Removed field
Other benefit	047	AnnanForman	0-1	Kryss	037	FK047 must exist if FK065 exists	Removed field

SKV 260 appendix 2	Version: 5.0
XML-struktur	2019-02-21

Term/Field Description	Code	Element name in XML	No.	Type	Controls		Change
					ID	Description	
Benefit has been adjusted	048	FormanHarJusterats	0-1	Kryss	038	If Fk048 exists and Fk031 and Fk025 are missing, then Fk012 or Fk013 must exist.	Changed field control
Benefit as pension	049	FormanSomPension	0-1	Kryss	040	If Fk049 exists, then Fk012 or Fk013 must exist.	Changed field control
Per diem	051	Traktamente	0-1	Kryss			New term/field description New Element name in XML
Per diem, other countries	052	TraktamenteUtomRiket	0-1	Kryss			Removed field
Business travels longer than three months, Sweden	053	TjansteresaOver3MInrikes	0-1	Kryss			Removed field
Business travels longer than three months, other countries	054	TjansteresaOver3MUtrikes	0-1	Kryss			Removed field
Business travel expenses	055	Resekostnader	0-1	Kryss			Removed field
Accommodation, business travels	056	Logi	0-1	Kryss			Removed field
Specification of other benefits at code 047	065	SpecAvAnnanForman	0-1	Text40	041	FK065 must exist if FK047 exists	Removed field
Specification of amount at code 037	070	SpecVissaAvdrag	0-1	Text40	042	FK070 must exist if FK037 exists	Removed field

KU13 – Special income tax for non-residents (SINK)

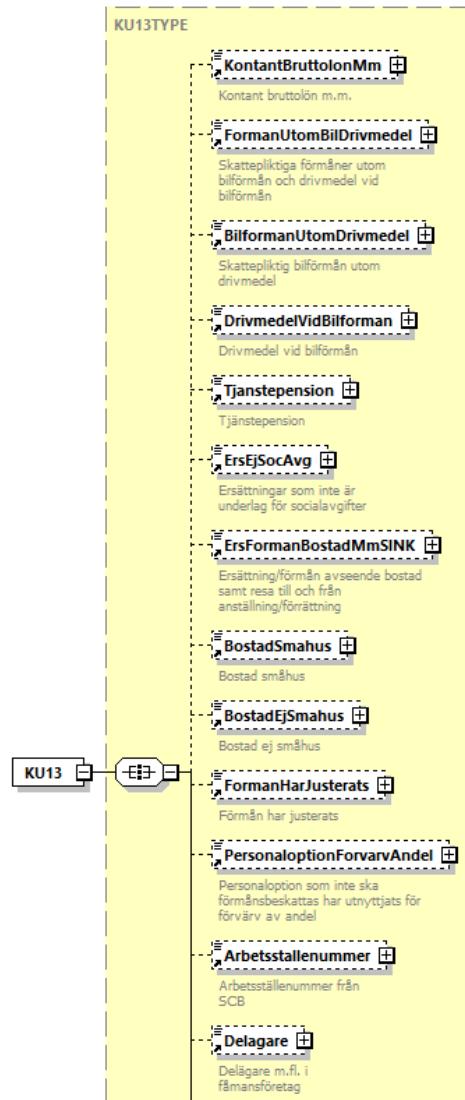

SKV 260 appendix 2	Version: 5.0
XML-struktur	2019-02-21

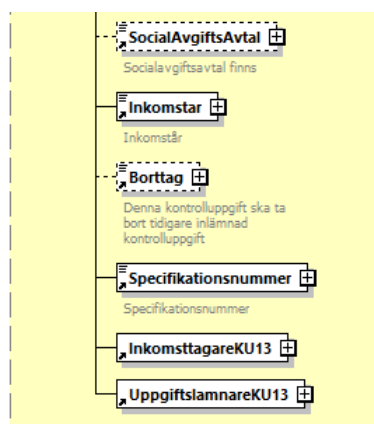

Description	Code	Element name in XML	No.	Type	ID	Description
Cash gross income etc.	011	KontantBruttolonMm	0-1	Belopp10	011, 183	Fk011 must exist if Fk205, Fk012, Fk013, Fk030, Fk031 and Fk036 are all missing. Fk011 cannot exist if Fk093 is missing.
Taxable benefits excl.employer-provided car and free fuel in connection with employer-provided car	012	FormanUtomBilDrivmedel	0-1	Belopp10	016, 184	If one or more of Fk041 and Fk043 exists and Fk031 is missing: Fk012 >= 0. Fk012 cannot exist if Fk093 is missing.
Taxable benefit of employer-provided car exclusive of fuel	013	BilformanUtomDrivmedel	0-1	Belopp7	185	Fk013 cannot exist if Fk093 is missing.
Free fuel in connection with employer-provided car	018	DrivmedelVidBilforman	0-1	Belopp7	183	Fk011 cannot exist if Fk093 is missing.
Occupational pension	030	Tjanstepension	0-1	Belopp10		
Remunerations for which social security contributions are not paid	031	ErsEjSocAvg	0-1	Belopp10	140	
Compensation for benefit of housing etc. SINK	036	ErsFormanBostadMmSINK	0-1	Belopp6		
Free housing 1- or 2-family house	041	BostadSmahus	0-1	Kryss		
Free housing other than code 41	043	BostadEjSmahus	0-1	Kryss		
Benefit has been adjusted	048	FormanHarJusterats	0-1	Kryss	039	If Fk048 exists and Fk031 is missing, then Fk012 or Fk013 must exist.

SKV 260 appendix 2	Version: 5.0
XML-struktur	2019-02-21

Description	Code	Element name in XML	No.	Type	ID	Description
Employee options that are not subject to preferential taxation have been utilized for acquisition of shares	059	PersonaloptionForvarvAndel	0-1	Kryss		
Number for work location	060	Arbetsstallenummer	0-1	ArbetsstalleNummer		
Partner	061	Delagare	0-1	Kryss		
Social security agreement	093	SocialAvgiftsAvtal	0-1	Kryss		
Income year	203	Inkomstar	1	Inkomstar		
Removal	205	Borttag	0-1	Kryss	055	FK205 can only exist if all codes but Fk201, Fk203, Fk570, Fk215, Fk222 and Fk224 are missing
Specification number	570	Specifikationsnummer	1	SpecifikationsNummer		
Income earner		InkomsttagareKU13	1	Grp		
Information provider		UppgiftslamnareKU13	1	Grp		

SKV 260 appendix 2	Version: 5.0
XML-struktur	2019-02-21

6.2.2.1 Element: *InkomsttagareKU13*

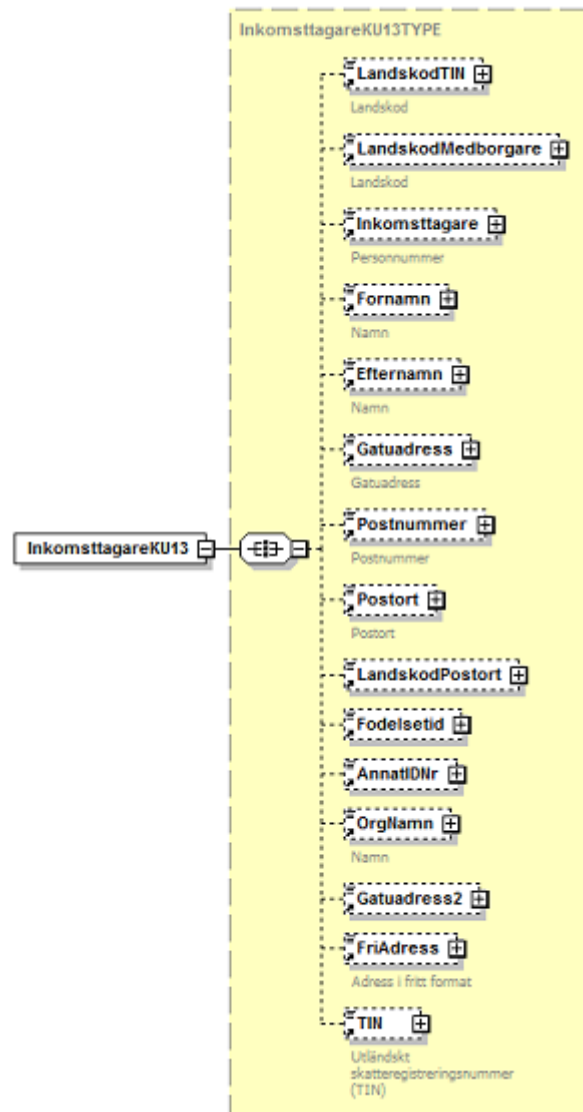

SKV 260 appendix 2	Version: 5.0
XML-struktur	2019-02-21

Term/Field Description	Code	Element name in XML	No.	Type	Controls	
					ID	Description
Country code for TIN	076	LandskodTIN	0-1	Landskod	045	FK076 must exist if FK252 exists.
Country code for citizenship	081	LandskodMedborgare	0-1	Landskod	048	FK081 must exist if FK250 exists.
Personal identity number	215	Inkomsttagare	0-1	Identitet	056	Fk215 must exist if Fk222 and Fk224 are missing.
Person's first name	216	Fornamn	0-1	Text50	057, 142	FK216 must exist if FK222 exists and FK205 is missing FK216 must exist if SSÅÅ > 1800 and DD > 60 in FK215 and Fk205 is missing
Person's last name	217	Efternamn	0-1	Text50	058, 143	FK217 must exist if FK222 exists and FK205 is missing FK217 must exist if SSÅÅ > 1800 and DD > 60 in FK215 and Fk205 is missing
Person's address	218	Gatuadress	0-1	Text50	059, 144, 152	FK218 must exist if FK222 exists and FK205 and FK230 is missing FK218 must exist if SSÅÅ > 1800 and DD > 60 in FK215 and FK205 and FK230 is missing FK218 must exist if FK224 exists and FK205 and FK215 and FK222 and FK230 is missing
Person's address continuing	228	Gatuadress2	0-1	Text50		
Person's post number	219	Postnummer	0-1	PostNummer	060, 145, 153	FK219 must exist if FK222 exists and FK 205 and FK230 is missing FK219 must exist if SSÅÅ > 1800 and DD > 60 in FK215 and Fk205 and FK230 is missing FK219 must exist if FK224 exists and FK205 and FK215 and FK222 and FK230 is missing
Person's postal location	220	Postort	0-1	Text50	061, 146, 154	FK220 must exist if FK222 exists and FK205 and FK230 is missing FK220 must exist if SSÅÅ > 1800 and DD > 60 in FK215 and Fk205 and FK230 is missing FK220 must exist if FK224 exists and FK205 and FK215 and FK222 and FK230 is missing
Country code for postal location	221	LandskodPostort	0-1	Landskod	166	FK221 must exist if FK230 exists
Date of birth	222	Fodelsetid	0-1	Fodelsetid	063	FK222 cannot exist if FK215 exists
Other ID number for a legal entity	224	AnnatIDNr	0-1	Text20		
Name of legal entity	226	OrgNamn	0-1	Text50	065, 151	FK226 cannot exist if Fk222 exists, if SS > 17 in FK215, if Fk216 exists or if Fk217 exists. FK226 must exist if FK224 exists and FK205, FK215, FK216, FK217 and FK222 is missing

SKV 260 appendix 2	Version: 5.0
XML-struktur	2019-02-21

Term/Field Description	Code	Element name in XML	No.	Type	Controls	
					ID	Description
Address in free format	230	FriAdress	0-1	Text350		
Foreign tax identification number (TIN).Other than Swedish.	252	TIN	0-1	Text20	066	FK252 must exist if FK076 exists

6.2.2.2 Element: UppgiftslamnareKU13

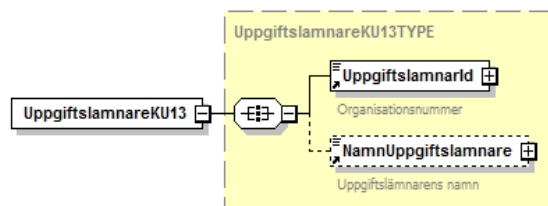

Term/Field Description	Code	Element name in XML	No.	Type	Controls	
					ID	Description
Information provider's organization number	201	UppgiftslamnarId	1	Identitet	053	FK201 cannot be equal to FK215
Information provider's name	202	NamnUppgiftslamnare	0-1	Text50		

6.2.2.3 Changes compared to income year 2018 in KU13

Term/Field Description	Code	Element name in XML	No.	Type	Controls		Changes
					ID	Description	
Tax deducted	001	AvdragenSkatt	0-1	Belopp10			Removed field
Period of employment as from	008	AnstalldFrom	0-1	Manad			Removed field
Period of employment up to	009	AnstalldTom	0-1	Manad	009	Fk009 must be >= Fk008	Removed field
Cash gross income etc.	011	KontantBruttolonMm	0-1	Belopp10	011, 183	Fk011 must exist if Fk205, Fk012, Fk013, Fk030, Fk031 and Fk036 are all missing. Fk011 cannot exist if Fk093 is missing.	Changed field control Added field control

SKV 260 appendix 2	Version: 5.0
XML-struktur	2019-02-21

Term/Field Description	Code	Element name in XML	No.	Type	Controls		Changes
					ID	Description	
Taxable benefits excl. employer-provided car and free fuel in connection with employer-provided car	012	FormanUtomBilDrivmedel	0-1	Belopp10	016, 184	If one or more of Fk041 and Fk043 exists and Fk031 is missing: Fk012 >= 0. Fk012 cannot exist if Fk093 is missing.	Changed field control Added field control
Taxable benefit of employer-provided car exclusive of fuel	013	BilformanUtomDrivmedel	0-1	Belopp7	185	Fk013 cannot exist if Fk093 is missing.	Changed field control Added field control
Code for employer-provided car	014	KodForFormansbil	0-1	Bilkod	030	FK014 must exist if FK013 exists	Removed field
Number of month with employer-provided car	015	AntalManBilforman	0-1	AntalManader			Removed field
Number of kilometers with car allowance for employer-provided car	016	KmBilersVidBilforman	0-1	AntalKm			Removed field
Employee's payment for employer-provided car	017	BetaltForBilforman	0-1	Belopp7			Removed field
Free meals	042	Kost	0-1	Kryss			Removed field
Interest	044	Ranta	0-1	Kryss			Removed field
Free parking	045	Parkering	0-1	Kryss			Removed field
Other benefit	047	AnnanForman	0-1	Kryss			Removed field
Benefit has been adjusted	048	FormanHarJusterats	0-1	Kryss	039	If Fk048 exists and Fk031 is missing, then Fk012 or Fk013 must exist.	Changed field control

SKV 260 appendix 2	Version: 5.0
XML-struktur	2019-02-21

6.2.3 KU14 – Pensionable income and exchange of income statements





SKV 260 appendix 2	Version: 5.0
XML-struktur	2019-02-21

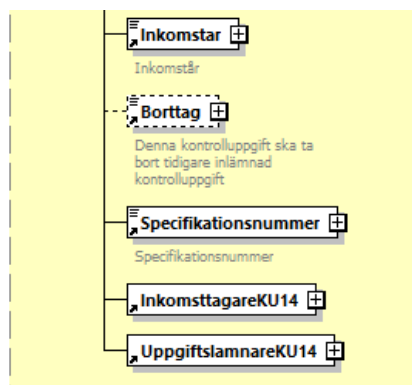

Term/Field Description	Code	Element name in XML	No.	Type	Controls	
					ID	Description
Cash gross income etc.	011	KontantBruttolonMm	0-1	Belopp10	012, 183	Fk011 must exist if Fk205, Fk012, Fk013, Fk020, Fk025, Fk030, Fk031, Fk035 and Fk050-051 are all missing. Fk011 cannot exist if Fk093 is missing.
Taxable benefits excl.employer-provided car and free fuel in connection with employer-provided car	012	FormanUtomBilDrivmedel	0-1	Belopp10	015, 017, 184	If one or more of Fk041 and Fk043 exists and Fk031 and Fk025 are missing: Fk012 >= 0. Fk012 or Fk031 or Fk025 must exist if Fk021 or Fk022 exists. Fk012 cannot exist if Fk093 is missing.
Taxable benefit of employer-provided car exclusive of fuel	013	BilformanUtomDrivmedel	0-1	Belopp7	185	Fk013 cannot exist if Fk093 is missing.
Free fuel in connection with employer-provided car	018	DrivmedelVidBilforman	0-1	Belopp7	186	Fk018 cannot exist if Fk093 is missing.
Compensation for expenses	020	AndraKostnadsers	0-1	Belopp7		
Basis for tax reduction for household services	021	UnderlagRutarbete	0-1	Belopp7		
Basis for tax reduction for "ROT-work".	022	UnderlagRotarbete	0-1	Belopp7		
Remuneration for which the employee pays social security contributions	025	ErsMEgenavgifter	0-1	Belopp10	139	Fk25 cannot exist if Fk93 exists
Occupational pension	030	Tjanstepension	0-1	Belopp10		

SKV 260 appendix 2	Version: 5.0
XML-struktur	2019-02-21

Term/Field Description	Code	Element name in XML	No.	Type	Controls	
					ID	Description
Remunerations for which social security contributions are not paid	031	ErsEjSocAvg	0-1	Belopp10		
Not taxable remunerations to foreign key persons according to decision from the Swedish Forskarskattenämnden	035	Forskarskattenamnden	0-1	Belopp10		
Free housing 1- or 2-family house	041	BostadSmahus	0-1	Kryss		
Free housing other than code 41	043	BostadEjSmahus	0-1	Kryss		
Benefit has been adjusted	048	FormanHarJusterats	0-1	Kryss	038	If FK048 exists and FK031 and Fk025 is missing must FK012 or FK013 exist
Benefit as pension	049	FormanSomPension	0-1	Kryss	040	If Fk049 exists, then Fk012 or Fk013 must exist.
Car allowance	050	Bilersattning	0-1	Kryss		
Per diem	051	Traktamente	0-1	Kryss		
Employee options that are not subject to preferential taxation have been utilized for acquisition of shares	059	PersonaloptionForvarvAndel	0-1	Kryss		
Number for work location	060	Arbetsstallenummer	0-1	ArbetsstalleNummer		
Partner	061	Delagare	0-1	Kryss		
Country code for country where work is performed	090	LandskodArbetsland	0-1	Landskod		
Time for work abroad	091	UtsandUnderTid	0-1	SandUnderTid		
Mark one of A-F	092	Kategori	0-1	KategoriKU14	050	Fk092 must exist if Fk205 is missing
Social security agreement exists	093	SocialAvgiftsAvtal	0-1	Kryss		
Income year	203	Inkomstar	1	Inkomstar		
Removal	205	Borttag	0-1	Kryss	055	FK205 can only exist if all codes but Fk201, Fk203, Fk570, Fk215, Fk222 and Fk224 are missing.
Specification number	570	Specifikationsnummer	1	SpecifikationsNummer		
Income earner		InkomsttagareKU14	1	Grp		
Information provider		UppgiftslamnareKU14	1	Grp		

SKV 260 appendix 2	Version: 5.0
XML-struktur	2019-02-21

6.2.3.1 Element: *InkomsttagareKU14*

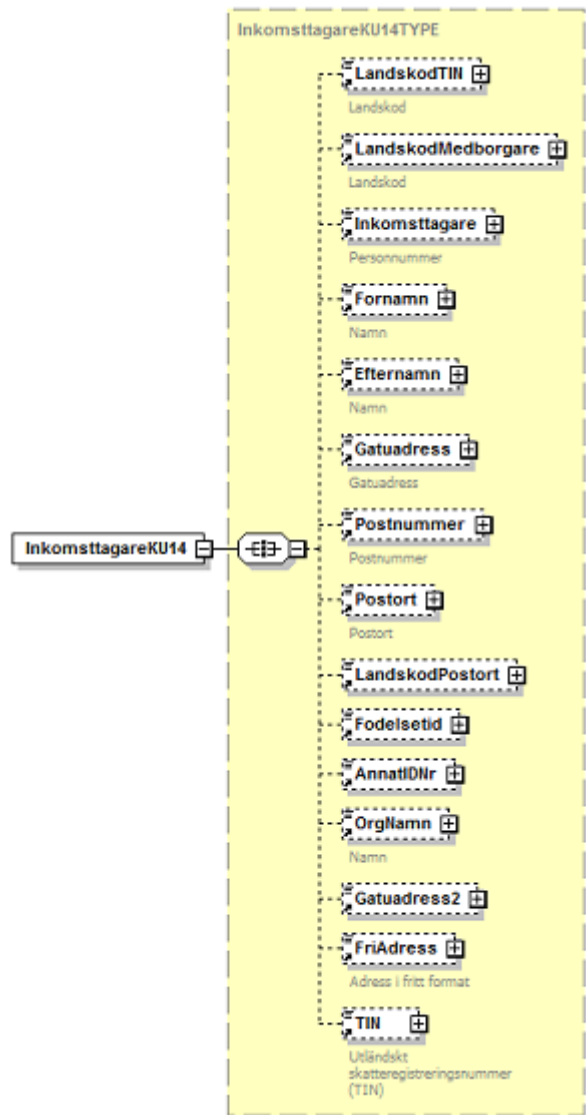

SKV 260 appendix 2	Version: 5.0
XML-struktur	2019-02-21

Term/Field Description	Code	Element name in XML	No.	Type	Controls	
					ID	Description
Country code for TIN	076	LandskodTIN	0-1	Landskod	045	FK076 must exist if FK252 exists.
Country code for citizenship	081	LandskodMedborgare	0-1	Landskod		
Personal identity number	215	Inkomsttagare	0-1	Identitet	056	Fk215 must exist if Fk222 and Fk224 are missing
Person's first name	216	Fornamn	0-1	Text50	057, 142	FK216 must exist if FK222 exists and FK 205 is missing FK216 must exist if CCYY > 1800 and DD > 60 in FK215 and Fk205 is missing
Person's last name	217	Efternamn	0-1	Text50	058, 143	FK217 must exist if FK222 exists and FK205 is missing FK217 must exist if CCYY > 1800 and DD > 60 in FK215 and Fk205 is missing
Person's address	218	Gatuadress	0-1	Text50	059, 144, 152	FK218 must exist if FK222 exists and FK205 and FK230 is missing FK218 must exist if CCYY > 1800 and DD > 60 in FK215 and Fk205 and FK230 is missing FK218 must exist if FK224 exists and FK205 and FK215 and FK222 and FK230 is missing
Person's address continuing	228	Gatuadress2	0-1	Text50		
Person's post number	219	Postnummer	0-1	PostNummer	060, 145, 153	FK219 must exist if FK222 exists and FK 205 and FK230 is missing FK219 must exist if CCYY > 1800 and DD > 60 in FK215 and Fk205 and FK230 is missing FK219 must exist if FK224 exists and FK205 and FK215 and FK222 and FK230 is missing
Person's postal location	220	Postort	0-1	Text50	061, 146, 154	FK220 must exist if FK222 exists and FK 205 and FK230 is missing FK220 must exist if CCYY > 1800 and DD > 60 in FK215 and Fk205 and FK230 is missing FK220 must exist if FK224 exists and FK205 and FK215 and FK222 and FK230 is missing
Country code for postal location	221	LandskodPostort	0-1	Landskod	166	FK221 must exist if FK230 exists.
Date of birth	222	Fodelsetid	0-1	Fodelsetid	063	FK222 cannot exist if FK215 exists
Other ID number for a legal entity	224	AnnatIDNr	0-1	Text20		

SKV 260 appendix 2	Version: 5.0
XML-struktur	2019-02-21

Term/Field Description	Code	Element name in XML	No.	Type	Controls	
					ID	Description
Name of legal entity	226	OrgNamn	0-1	Text50	065, 151	FK226 cannot exist if Fk222 exists, if CC > 17 in FK215, if Fk216 exists or if Fk217 exists. FK226 must exist if FK224 exists and FK205, FK215, FK216, FK217 and FK222 is missing
Address in free format	230	FriAdress	0-1	Text350		
Foreign tax identification number (TIN). Other than Swedish	252	TIN	N	Text20	066	FK252 must exist if FK076 exists

6.2.3.2 Element: UppgiftslamnareKU14

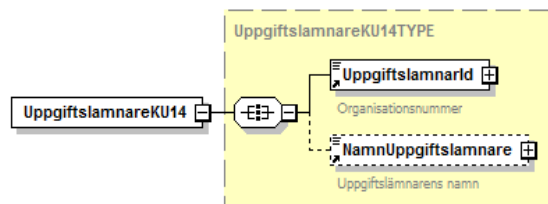

Term/Field Description	Code	Element name in XML	No.	Type	Controls	
					ID	Description
Information provider's organization number	201	Uppgiftslamnard	1	Identitet	053	FK201 cannot be equal to FK215
Information provider's name	202	NamnUppgiftslamnare	0-1	Text50		

6.2.3.3 Changes compared to income year 2018 in KU14

Term/Field Description	Code	Element name in XML	No.	Type	Controls		Changes
					ID	Description	
Period of employment as from	008	AnstalldFrom	0-1	Manad			Removed field
Period of employment up to	009	AnstalldTom	0-1	Manad	009	Fk009 must be >= Fk008	Removed field
Cash gross income etc.	011	KontantBruttolonMm	0-1	Belopp10	012, 183	Fk011 must exist if Fk205, Fk012, Fk013, Fk020, Fk025, Fk030, Fk031, Fk035 and Fk050-051 are all missing. Fk011 cannot exist if Fk093 is missing.	Changed field control Added field control

SKV 260 appendix 2	Version: 5.0
XML-struktur	2019-02-21

Term/Field Description	Code	Element name in XML	No.	Type	Controls		Changes
					ID	Description	
Taxable benefits excl. employer-provided car and free fuel in connection with employer-provided car	012	FormanUtomBilDrivmedel	0-1	Belopp10	015, 017, 184	If one or more of Fk041 and Fk043 exists and Fk031 and Fk025 are missing: Fk012 >= 0. Fk012 or Fk031 or Fk025 must exist if Fk021 or Fk022 exists. Fk012 cannot exist if Fk093 is missing.	Changed field control Added field control
Taxable benefit of employer-provided car exclusive of fuel	013	BilformanUtomDrivmedel	0-1	Belopp7	185	Fk013 cannot exist if Fk093 is missing.	Removed field control Added field control
Code for employer-provided car	014	KodForFormansbil	0-1	Bilkod	030	If FK013 exists must FK014 exist	Removed field
Number of months with employer-provided car	015	AntalManBilforman	0-1	AntalManader			Removed field
Number of kilometers with car allowance for employer-provided car	016	KmBilersVidBilforman	0-1	AntalKm			Removed field
Employee's payment for employer-provided car	017	BeltForBilforman	0-1	Belopp7			Removed field
Free fuel in connection with employer-provided car	018	DrivmedelVidBilforman	0-1	Belopp7	186	Fk018 cannot exist if Fk093 is missing.	Added field control
Free meals	042	Kost	0-1	Kryss			Removed field
Interest	044	Ranta	0-1	Kryss			Removed field
Free parking	045	Parkering	0-1	Kryss			Removed field
Other benefit	047	AnnanForman	0-1	Kryss			Removed field
Benefit as pension	049	FormanSomPension	0-1	Kryss	040	If Fk049 exists, then Fk012 or Fk013 must exist.	Changed field control
Per diem	051	Traktamente	0-1	Kryss			New term/field description New Element name in XML
Per diem, other countries	052	TraktamenteUtomRiket	0-1	Kryss			Removed field
Business travels longer than three months, Sweden	053	TjansteresaOver3MInrikes	0-1	Kryss			Removed field
Business travels longer than three months, other countries	054	TjansteresaOver3MUtrikes	0-1	Kryss			Removed field
Business travel expenses	055	Resekostnader	0-1	Kryss			Removed field
Accommodation, business travels	056	Logi	0-1	Kryss			Removed field

SKV 260 appendix 2	Version: 5.0
XML-struktur	2019-02-21

6.2.4 KU16 – Statements regarding maritime income, etc.

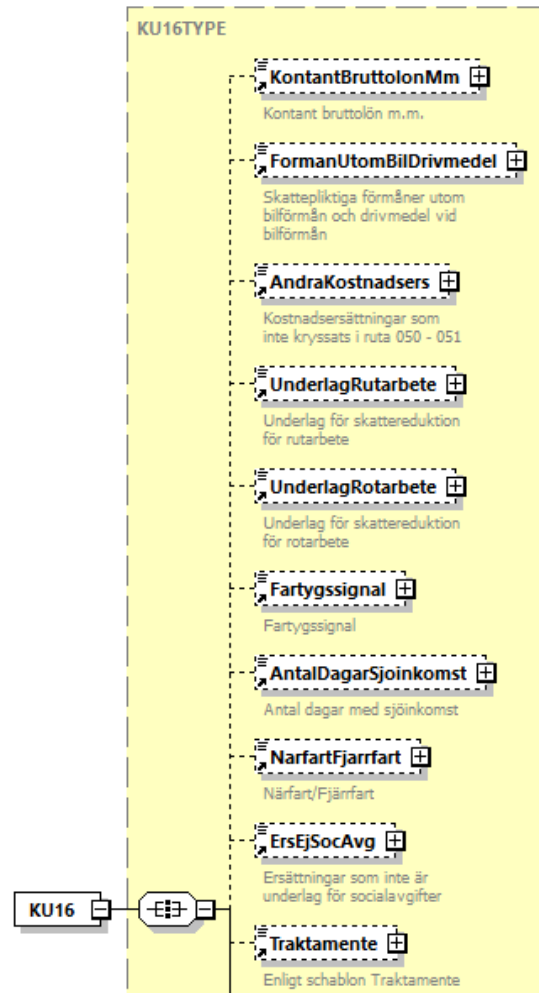

SKV 260 appendix 2	Version: 5.0
XML-struktur	2019-02-21

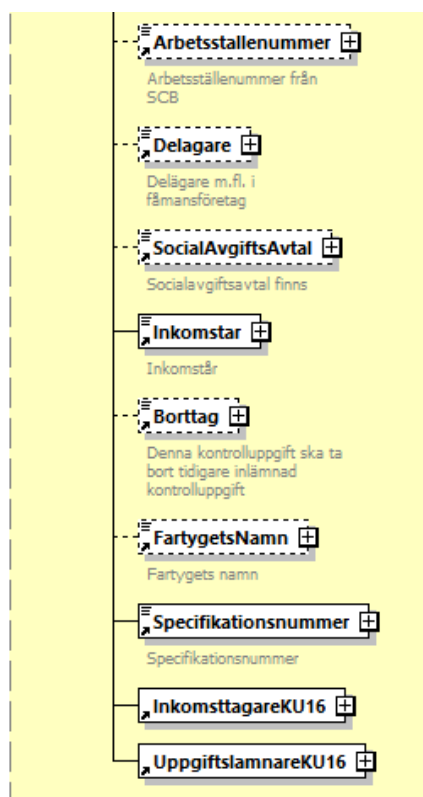

Term/Field	Description	Code	Element name in XML	No.	Type	Controls	
						ID	Description
	Cash gross income etc.	011	KontantBruttolonMm	0-1	Belopp10	013, 183	Fk011 must exist if Fk205, Fk012, Fk020, Fk031 and Fk051 are all missing. Fk011 cannot exist if Fk093 is missing.
	Taxable benefits excl. employer-provided car and free fuel in connection with employer-provided car	012	FormanUtombilDrivmedel	0-1	Belopp10	184	Fk012 cannot exist if Fk093 is missing.
	Compensation for expenses	020	AndraKostnadsers	0-1	Belopp7		

SKV 260 appendix 2	Version: 5.0
XML-struktur	2019-02-21

Term/Field Description	Code	Element name in XML	No.	Type	Controls	
					ID	Description
Basis for tax reduction for household services	021	UnderlagRutarbete	0-1	Belopp7		
Basis for tax reduction for "ROT-work"	022	UnderlagRotarbete	0-1	Belopp7		
Vessel signal	026	Fartygssignal	0-1	Fartygssignal	031	FK026 must exist if FK205 is missing
Number of days	027	AntalDagarSjoinkomst	0-1	Dagar	032	FK027 must exist if FK205 is missing
Short sea shipping/Long haul	028	NarfartFjarrfart	0-1	NarfartFjarrfart	033	FK028 must exist if FK205 is missing
Remunerations for which social security contributions are not paid	031	ErsEjSocAvg	0-1	Belopp10		
Per diem	051	Traktamente	0-1	Kryss		
Number for work location	060	Arbetsstallenummer	0-1	ArbetsstalleNummer		
Partner	061	Delagare	0-1	Kryss		
Social security agreement exists	093	SocialAvgiftsAvtal	0-1	Kryss		
Income year	203	Inkomstar	1	Inkomstar		
Removal	205	Borttag	0-1	Kryss	055	FK205 can only exist if all codes but Fk201, Fk203, Fk570, Fk215, Fk222 and Fk224 are missing.
Name of vessel	223	FartygetsNamn	0-1	Text50	064	FK223 must exist if FK205 is missing
Specification number	570	Specifikationsnummer	1	SpecifikationsNummer		
Income earner		InkomsttagareKU16	1	Grp		
Information provider		UppgiftslamnareKU16	1	Grp		

SKV 260 appendix 2	Version: 5.0
XML-struktur	2019-02-21

6.2.4.1 Element: InkomsttagareKU16

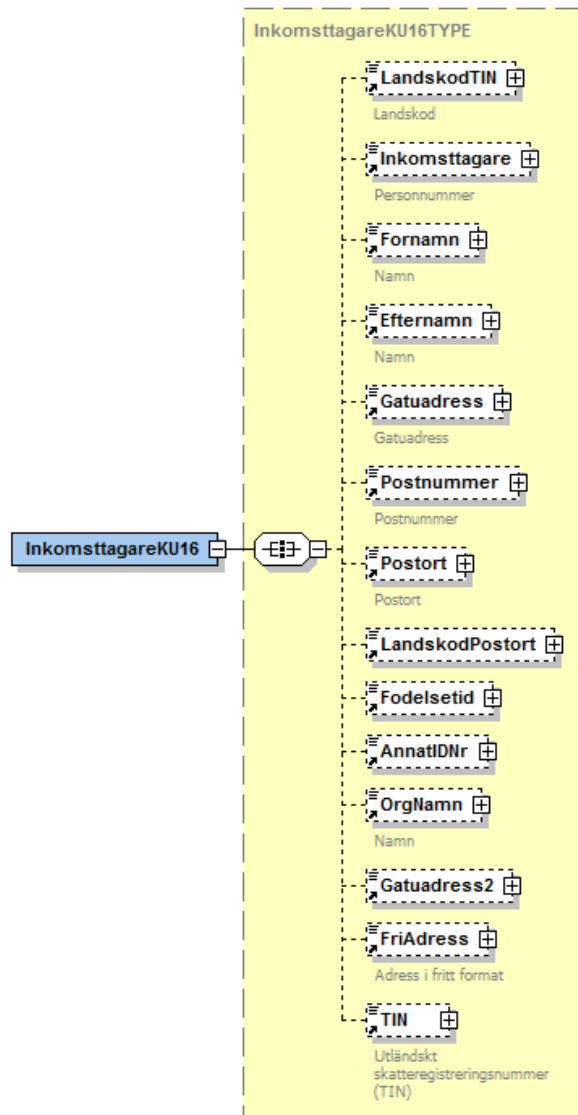

SKV 260 appendix 2	Version: 5.0
XML-struktur	2019-02-21

Term/Field	Code	Element name in XML	No.	Type	Controls	
					ID	Description
Country code TIN	076	Landskod TIN	0-1	Landskod	045	FK076 must exist if FK252 exists
Personal identity number	215	Inkomsttagare	0-1	Identitet	056	Fk215 must exist if Fk222 and Fk224 are missing.
Person's first name	216	Fornamn	0-1	Text50	057, 142	FK216 must exist if FK222 exists and FK 205 is missing FK216 must exist if CCYY > 1800 and DD > 60 in FK215 and Fk205 is missing
Person's last name	217	Efternamn	0-1	Text50	058, 143	FK217 must exist if FK222 exists and FK 205 is missing FK217 must exist if CCYY > 1800 and DD > 60 in FK215 and Fk205 is missing
Person's address	218	Gatuadress	0-1	Text50	059, 144, 152	FK218 must exist if FK222 exists and FK 205 and FK230 is missing FK218 must exist if CCYY > 1800 and DD > 60 in FK215 and Fk205 and FK230 is missing FK218 must exist if FK224 exists and FK205 and FK215 and FK222 and FK230 is missing
Person's address continuing	228	Gatuadress2	0-1	Text50		
Person's post number	219	Postnummer	0-1	PostNummer	060, 145, 153	FK219 must exist if FK222 exists and FK 205 and FK230 is missing FK219 must exist if CCYY > 1800 and DD > 60 in FK215 and Fk205 and FK230 is missing FK219 must exist if FK224 exists and FK205 and FK215 and FK222 and FK230 is missing
Person's postal location	220	Postort	0-1	Text50	061, 146, 154	FK220 must exist if FK222 exists and FK 205 and FK230 is missing FK220 must exist if CCYY > 1800 and DD > 60 in FK215 and Fk205 and FK230 is missing FK220 must exist if FK224 exists and FK205 and FK215 and FK222 and FK230 is missing
Country code for postal location	221	LandskodPostort	0-1	Landskod	166	FK221 must exist if FK230 exists.
Date of birth	222	Fodelsetid	0-1	Fodelsetid	063	FK222 can not exist if FK215 exists
Other ID number for a legal entity	224	AnnatIDNr	0-1	Text20		
Name of legal entity	226	OrgNamn	0-1	Text50	065,	FK226 can not exist if Fk222 exists, if CC > 17 in FK215, if Fk216 exists or if Fk217 exists.

SKV 260 appendix 2	Version: 5.0
XML-struktur	2019-02-21

Term/Field Description	Code	Element name in XML	No.	Type	Controls	
					ID	Description
					151	FK226 must exist if FK224 exists and FK205 and FK215, FK216, FK217 and FK222 is missing
Address in free format	230	FriAdress	0-1	Text350		
TIN	252	TIN	0-1	Text20	066	FK252 must exist if FK078 exists

6.2.4.2 Element: UppgiftslamnareKU16

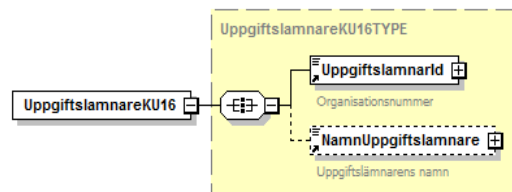

Term/Field Description	Code	Element name in XML	No.	Type	Controls	
					Id	Description
Information provider's organization number	201	UppgiftslamnarId	1	Identitet	053	FK201 can not be equal to FK215
Information provider's name	202	NamnUppgiftslamnare	0-1	Text50		

6.2.4.3 Changes compared to income year 2018 in KU16

Term/Field Description	Code	Element name in XML	No.	Type	Controls		Changes
					ID	Description	
Tax deducted	001	AvdragenSkatt	0-1	Belopp10			Removed field
Month as from	008	AnstalldFrom	0-1	Manad			Removed field
Month up to	009	AnstalldTom	0-1	Manad			Removed field
Cash gross income etc.	011	KontantBruttolonMm	0-1	Belopp10	013, 183	Fk011 must exist if Fk205, Fk012, Fk020, Fk031 and Fk051 are all missing. Fk011 cannot exist if Fk093 is missing.	Changed field control Added field control

SKV 260 appendix 2	Version: 5.0
XML-struktur	2019-02-21

Term/Field Description	Code	Element name in XML	No.	Type	Controls		Changes
					ID	Description	
Taxable benefits excl. employer-provided car and free fuel in connection with employer-provided car	012	FormanUtomBilDrivmedel	0-1	Belopp10	184	Fk012 cannot exist if Fk093 is missing.	Removed field control Added field control
Free meals	042	Kost	0-1	Kryss			Removed field
Per diem	051	Traktamente	0-1	Kryss			New term/field description New Element name in XML
Per diem, other countries	052	TraktamenteUtomRiket	0-1	Kryss			Removed field

6.2.5 KU17 – Special income statement – Special income tax (for non-residents, SINK) for foreign residents with maritime income

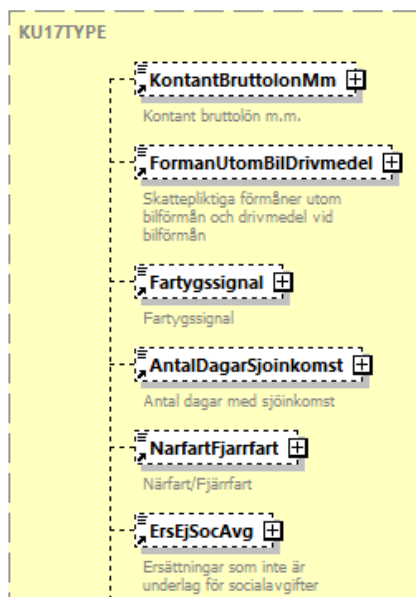

SKV 260 appendix 2	Version: 5.0
XML-struktur	2019-02-21

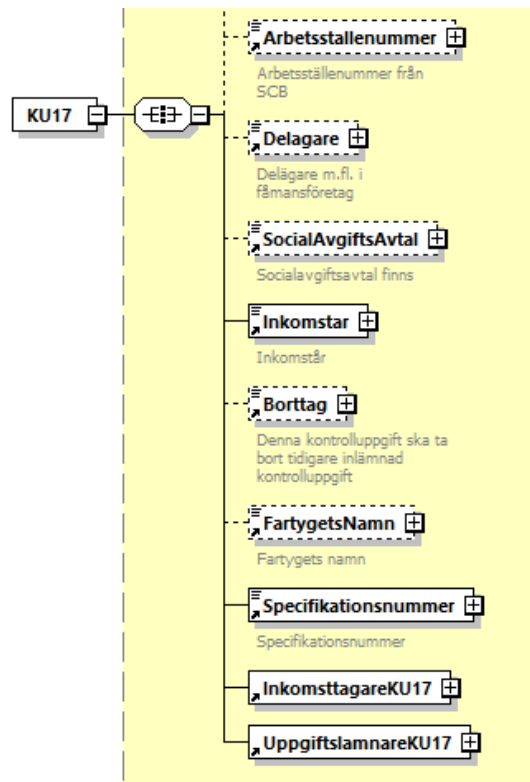

Term/Field	Code	Element name in XML	No.	Type	Controls	
					Id	Description
Cash gross income etc.	011	KontantBruttolonMm	0-1	Belopp10	014, 183	Fk011 must exist if Fk205, Fk012 and Fk031 are all missing. Fk011 cannot exist if Fk093 is missing.
Taxable benefits excl.employer-provided car and free fuel in connection with employer-provided car	012	FormanUtomBilDrivmedel	0-1	Belopp10	184	Fk012 cannot exist if Fk093 is missing.
Vessel signal	026	Fartygssignal	0-1	Fartygssignal	031	FK026 must exist if FK205 is missing
Number of days	027	AntalDagarSjoinkomst	0-1	Dagar	032	FK027 must exist if FK205 is missing

SKV 260 appendix 2	Version: 5.0
XML-struktur	2019-02-21

Term/Field Description	Code	Element name in XML	No.	Type	Controls	
					Id	Description
Short sea shipping/Long haul	028	NarfartFjarrfart	0-1	NarfartFjarrfart	033	FK028 must exist if FK205 is missing
Remunerations for which social security contributions are not paid	031	ErsEjSocAvg	0-1	Belopp10	140	Fk31 can not exist if Fk93 exists
Number for work location	060	Arbetsstallenummer	0-1	ArbetsstalleNummer		
Partner	061	Delagare	0-1	Kryss		
Social security agreement exists	093	SocialAvgiftsAvtal	0-1	Kryss		
Income year	203	Inkomstar	1	Inkomstar		
Removal	205	Borttag	0-1	Kryss	055	FK205 can only exist if all codes but Fk201, Fk203, Fk570, Fk215, Fk222 and Fk224 are missing.
Name of vessel	223	FartygetsNamn	0-1	Text50	064	FK223 must exist if FK205 is missing
Specification number	570	Specifikationsnummer	1	SpecifikationsNummer		
Income earner		InkomsttagareKU17	1	Grp		
Information provider		UppgiftslamnareKU17	1	Grp		

SKV 260 appendix 2	Version: 5.0
XML-struktur	2019-02-21

6.2.5.1 Element: *InkomsttagareKU17*

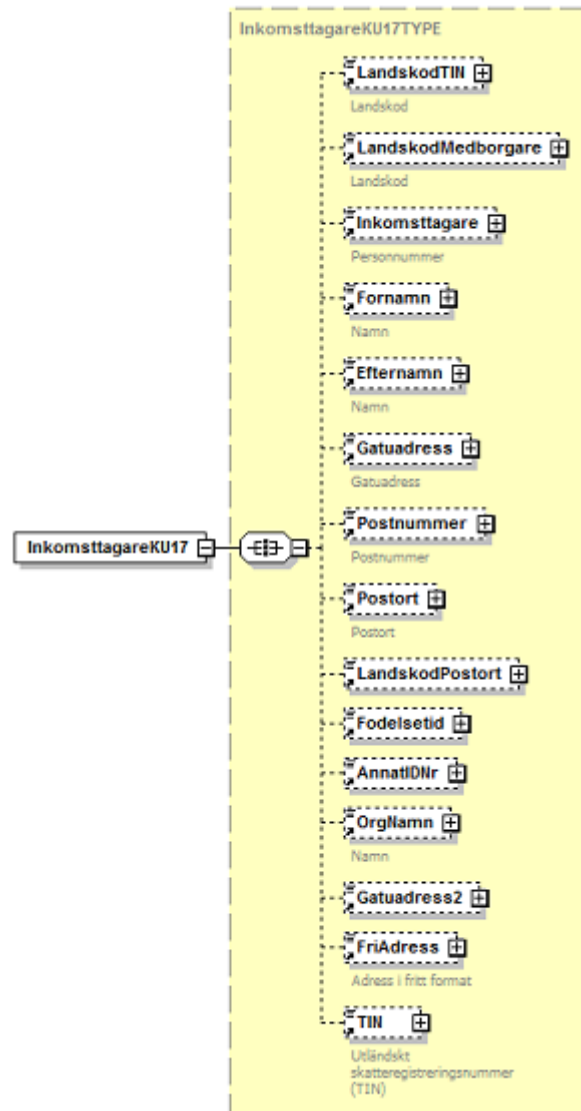

SKV 260 appendix 2	Version: 5.0
XML-struktur	2019-02-21

Term/Field		Element name in XML	No.	Type	Controls	
Description	Code				Id	Description
Country code for TIN	076	LandskodTIN	0-1	Landskod	045	FK076 must exist if FK252 exists.
Country code for citizenship	081	LandskodMedborgare	0-1	Landskod		
Personal identity number	215	Inkomsttagare	0-1	Identitet	056	Fk215 must exist if Fk222 and Fk224 are missing.
Person's first name	216	Fornamn	0-1	Text50	057, 142	FK216 must exist if FK222 exists and FK 205 is missing FK216 must exist if CCYY > 1800 and DD > 60 in FK215 and Fk205 is missing
Person's last name	217	Efternamn	0-1	Text50	058, 143	FK217 must exist if FK222 exists and FK 205 is missing FK217 must exist if CCYY > 1800 and DD > 60 in FK215 and Fk205 is missing
Person's address	218	Gatuadress	0-1	Text50	059, 144, 152	FK218 must exist if FK222 exists and FK 205 and FK230 is missing FK218 must exist if CCYY > 1800 and DD > 60 in FK215 and Fk205 and FK230 is missing FK218 must exist if FK224 exists and FK205 and FK215 and FK222 and FK230 is missing
Person's address continuing	228	Gatuadress2	0-1	Text50		
Person's post number	219	Postnummer	0-1	PostNummer	060, 145, 153	FK219 must exist if FK222 exists and FK 205 and FK230 is missing FK219 must exist if CCYY > 1800 and DD > 60 in FK215 and Fk205 and FK230 is missing FK219 must exist if FK224 exists and FK205 and FK215 and FK222 and FK230 is missing
Person's postal location	220	Postort	0-1	Text50	061, 146, 154	FK220 must exist if FK222 exists and FK 205 and FK230 is missing FK220 must exist if CCYY > 1800 and DD > 60 in FK215 and Fk205 and FK230 is missing FK220 must exist if FK224 exists and FK205 and FK215 and FK222 and FK230 is missing
Country code for postal location	221	LandskodPostort	0-1	Landskod	166	FK221 must exist if FK230 exists
Date of birth	222	Fodelsetid	0-1	Fodelsetid	063	FK222 can not exist if FK215 exists
Other ID number for a legal entity	224	AnnatIDNr	0-1	Text20		
Name of legal entity	226	OrgNamn	0-1	Text50	065,	FK226 can not exist if Fk222 exists, if CC > 17 in FK215, if Fk216 exists or if Fk217 exists.

SKV 260 appendix 2	Version: 5.0
XML-struktur	2019-02-21

Term/Field Description	Code	Element name in XML	No.	Type	Controls	
					Id	Description
					151	FK226 must exist if FK224 exists and FK205, FK215, FK216, FK217 and FK222 is missing
Address in free format	230	FriAdress	0-1	Text350		
Foreign tax identification number (TIN). Other than Swedish	252	TIN	0-1	Text20	066	FK252 must exist if FK076 exists

6.2.5.2 Element: UppgiftslamnareKU17

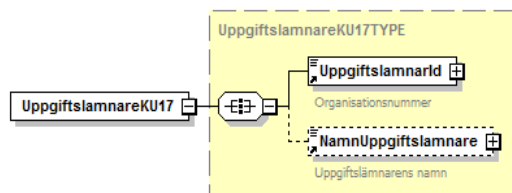

Term/Field Description	Code	Element name in XML	No.	Type	Controls	
					Id	Description
Information provider's organization number	201	UppgiftslamnarId	1	Identitet	053	FK201 can not be equal to FK215
Information provider's name	202	NamnUppgiftslamnare	0-1	Text50		

6.2.5.3 Changes compared to income year 2018 in KU17

Term/Field Description	Code	Element name in XML	No.	Type	Controls		Changes
					ID	Description	
Tax deducted	001	AvdragenSkatt	0-1	Belopp10			Removed field
Period of employment as from	008	AnstalldFrom	0-1	Manad			Removed field
Period of employment up to	009	AnstalldTom	0-1	Manad	009	Fk009 must be >= Fk008	Removed field
Cash gross income etc.	011	KontantBruttolonMm	0-1	Belopp10	014, 183	Fk011 must exist if Fk205, Fk012 and Fk031 are all missing. Fk011 cannot exist if Fk093 is missing.	Changed field control Added field control

SKV 260 appendix 2	Version: 5.0
XML-struktur	2019-02-21

Term/Field Description	Code	Element name in XML	No.	Type	Controls		Changes
					ID	Description	
Taxable benefits excl.employer-provided car and free fuel in connection with employer-provided car	012	FormanUtomBilDrivmedel	0-1	Belopp10	184	Fk012 cannot exist if Fk093 is missing.	Removed field control Added field control
Free meals	042	Kost	0-1	Kryss			Removed field

SKV 260 appendix 2	Version: 5.0
XML-struktur	2019-02-21

6.2.6 KU18 – Income statement from the pension and insurance payer etc.

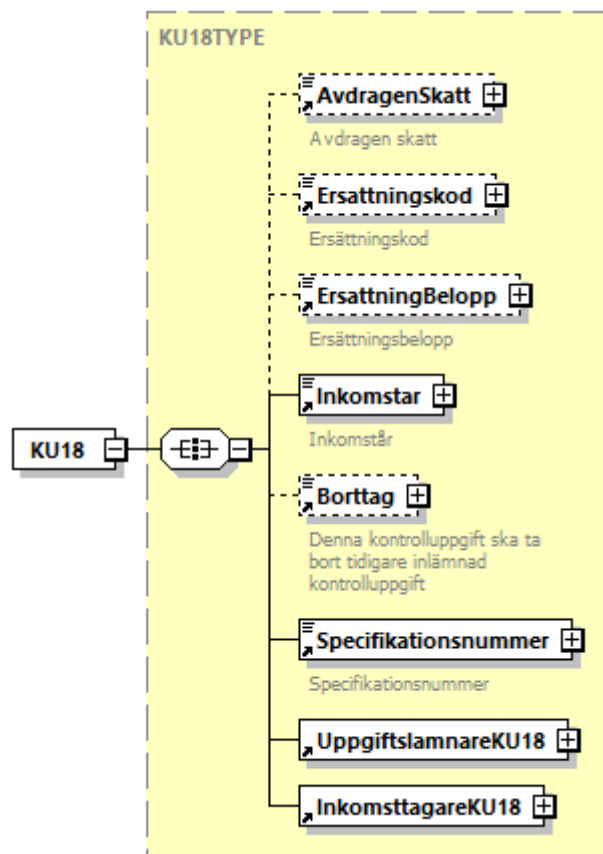

Term/Field Description	Code	Element name in XML	No.	Type	Controls	
					Id	Description
Tax deducted	001	AvdragenSkatt	0-1	Belopp10	001	Fk001 must exist if Fk205, Fk004 and Fk005 are missing
Remuneration code	004	Ersattningskod	0-1	Ersattningskod	007	FK004 must exist if FK005 exists
Amount in the current currency	005	ErsattningBelopp	0-1	Belopp10	008	FK005 must exist if FK004 exists.
Income year	203	Inkomstar	1	Inkomstar		

SKV 260 appendix 2	Version: 5.0
XML-struktur	2019-02-21

Term/Field Description	Code	Element name in XML	No.	Type	Controls	
					Id	Description
Removal	205	Borttag	0-1	Kryss	055	FK205 can only exist if all codes but Fk201, Fk203, Fk570, Fk215, Fk222 and Fk224 are missing.
Insurance agreement number	507	Forsakringsavtalsnummer	0-1	Text30		
Specification number	570	Specifikationsnummer	1	SpecifikationsNummer		
Income earner		InkomsttagareKU18	1	Grp		
information provider		UppgiftslamnareKU18	1	Grp		

SKV 260 appendix 2	Version: 5.0
XML-struktur	2019-02-21

6.2.6.1 Element: *InkomstagareKU18*

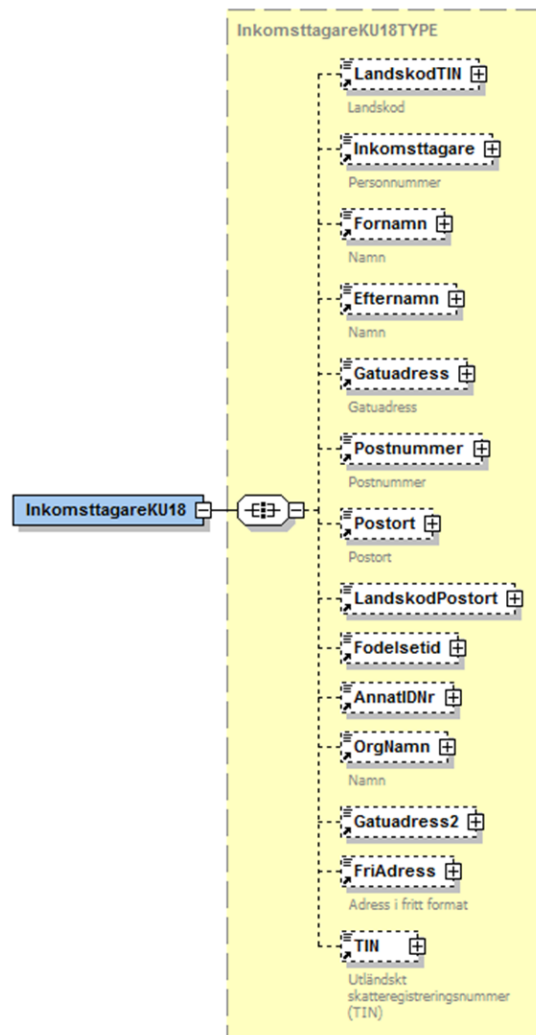

SKV 260 appendix 2	Version: 5.0
XML-struktur	2019-02-21

Term/Field Description	Code	Element name in XML	No.	Type	Controls	
					Id	Description
Country code TIN	076	Landskod TIN	0-1	Landskod	045	FK076 must exist if FK252 exists
Personal identity number	215	Inkomsttagare	0-1	Identitet	056	Fk215 must exist if Fk222 and Fk224 are missing.
Person's first name	216	Fornamn	0-1	Text50	057, 142	FK216 must exist if FK222 exists and FK 205 is missing FK216 must exist if CCYY > 1800 and DD > 60 in FK215 and Fk205 is missing
Person's last name	217	Efternamn	0-1	Text50	058, 143	FK217 must exist if FK222 exists and FK 205 is missing FK217 must exist if CCYY > 1800 and DD > 60 in FK215 and Fk205 is missing
Person's address	218	Gatuadress	0-1	Text50	059, 144, 152	FK218 must exist if FK222 exists and FK 205 and FK230 is missing FK218 must exist if CCYY > 1800 and DD > 60 in FK215 and Fk205 and FK230 is missing FK218 must exist if FK224 exists and FK205 and FK215 and FK222 and FK230 is missing
Person's address continuing	228	Gatuadress2	0-1	Text50		
Person's post number	219	Postnummer	0-1	PostNummer	060, 145, 153	FK219 must exist if FK222 exists and FK 205 and FK230 is missing FK219 must exist if CCYY > 1800 and DD > 60 in FK215 and Fk205 FK230 is missing FK219 must exist if FK224 exists and FK205 and FK215 and FK222 and FK230 is missing
Person's postal location	220	Postort	0-1	Text50	061, 146, 154	FK220 must exist if FK222 exists and FK 205 and FK230 is missing FK220 must exist if CCYY > 1800 and DD > 60 in FK215 and Fk205 and FK230 is missing FK220 must exist if FK224 exists and FK205 and FK215 and FK222 and FK230 is missing
Country code for postal location	221	LandskodPostort	0-1	Landskod	166	FK221 must exist if FK230 exists.
Date of birth	222	Fodelsetid	0-1	Fodelsetid	063	FK222 cannot exist if FK215 exists
Other ID number for a legal entity	224	AnnatIDNr	0-1	Text20		
Name of legal entity	226	OrgNamn	0-1	Text50	065, 151	FK226 can not exist if Fk222 exists, if CC > 17 in FK215, if Fk216 exists or if Fk217 exists. FK226 must exist if FK224 exists and FK205, FK215, FK216, FK217 and FK222 is missing
Address in free format	230	FriAdress	0-1	Text350		

SKV 260 appendix 2	Version: 5.0
XML-struktur	2019-02-21

Term/Field Description	Code	Element name in XML	No.	Type	Controls	
					Id	Description
TIN	252	TIN	0-1	Text20	066	FK252 must exist if FK078 exists

6.2.6.2 Element: UppgiftslamnareKU18

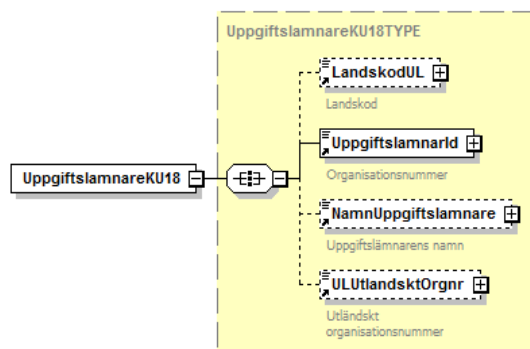

Term/Field Description	Code	Element name in XML	No.	Type	Controls	
					Id	Description
Country code for foreign organization number	075	LandskodUL	0-1	Landskod	043	Fk075 must exist if Fk506 exists
Information provider's organization number	201	Uppgiftslamnarid	1	Identitet	053	FK201 can not be equal to FK215
Information provider's name	202	NamnUppgiftslamnare	0-1	Text50		
Information provider's foreign organization number	506	ULUtlandsktOrgnr	0-1	Text13	072	Fk506 must exist if Fk075 exists

6.2.6.3 Changes compared to income year 2018 in KU18

Term/Field Description	Code	Element name in XML	No.	Type	Controls		Changes
					Id	Description	
Insurance agreement number	507	Forsakringsavtalsnummer	0-1	Text30			Removed field

SKV 260 appendix 2	Version: 5.0
XML-struktur	2019-02-21

6.2.7 KU19 – Income statement special income tax for non-residents (SINK) from the pension and insurance payer

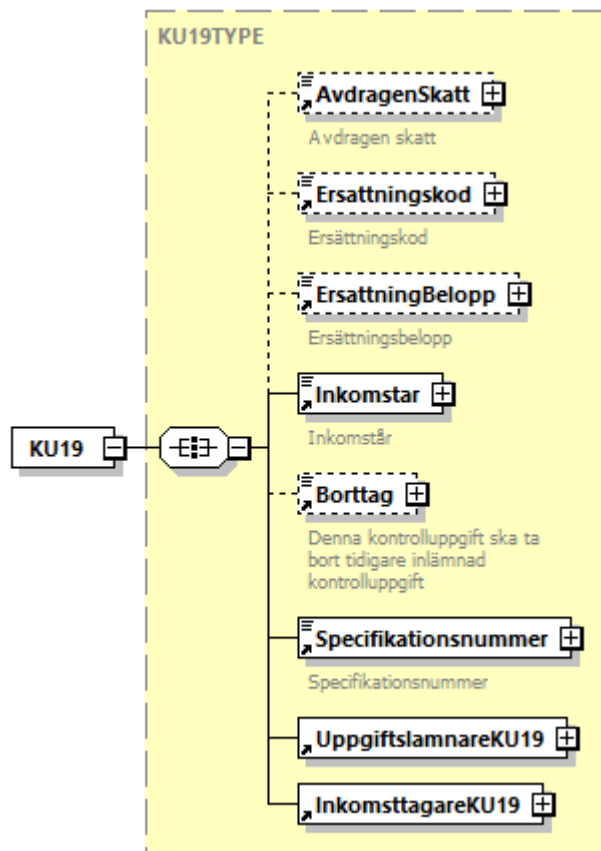

Term/Field	Code	Element name in XML	No.	Type	Controls	
					Id	Description
Tax deducted	001	AvdragenSkatt	0-1	Belopp10	001	Fk001 must exist if Fk205, Fk004 and Fk005 are missing
Remuneration code. See table for remuneration code on website	004	Ersattningskod	0-1	Ersattningskod	007	FK004 must exist if FK005 exists

SKV 260 appendix 2	Version: 5.0
XML-struktur	2019-02-21

Term/Field		Element name in XML	No.	Type	Controls	
Description	Code				Id	Description
Amount in the current currency	005	ErsattningBelopp	0-1	Belopp10	008	FK005 must exist if FK004 exists.
Income year	203	Inkomstar	1	Inkomstar		
Removal	205	Borttag	0-1	Kryss	055	FK205 can only exist if all codes but Fk201, Fk203, Fk570, Fk215, Fk222 and Fk224 are missing
Insurance agreement number	507	Forsakringsavtalsnummer	0-1	Text30		
Specification number	570	Specifikationsnummer	1	SpecifikationsN ummer		
Income earner		InkomsttagareKU19	1	Grp		
Information provider		UppgiftslamnareKU19	1	Grp		

SKV 260 appendix 2	Version: 5.0
XML-struktur	2019-02-21

6.2.7.1 Element: *InkomsttagareKU19*

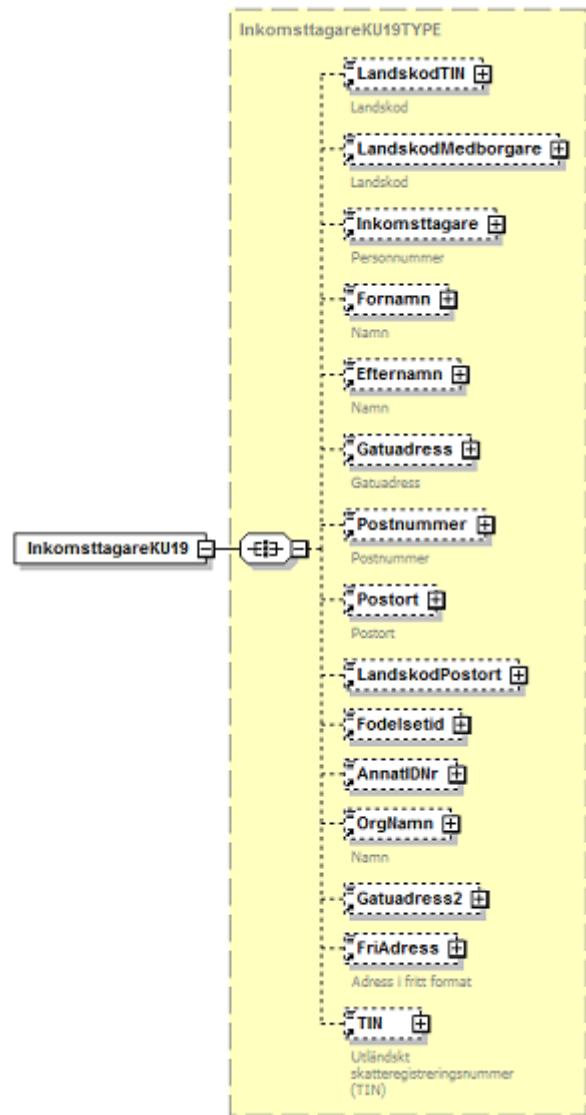

SKV 260 appendix 2	Version: 5.0
XML-struktur	2019-02-21

Term/Field Description	Code	Element name in XML	No.	Type	Controls	
					Id	Description
Country code for TIN	076	LandskodTIN	0-1	Landskod	045	FK076 must exist if FK252 exists
Country code for citizenship	081	LandskodMedborgare	0-1	Landskod		
Personal identity number	215	Inkomsttagare	0-1	Identitet	056	Fk215 must exist if Fk222 and Fk224 are missing
Person's first name	216	Fornamn	0-1	Text50	057, 142	FK216 must exist if FK222 exists and FK 205 is missing FK216 must exist if CCYY > 1800 and DD > 60 in FK215 and Fk205 is missing
Person's last name	217	Efternamn	0-1	Text50	058, 143	FK217 must exist if FK222 exists and FK 205 is missing FK217 must exist if CCYY > 1800 and DD > 60 in FK215 and Fk205 is missing
Person's address	218	Gatuadress	0-1	Text50	059, 144, 152	FK218 must exist if FK222 exists and FK 205 and FK230 is missing FK218 must exist if CCYY > 1800 and DD > 60 in FK215 and Fk205 and FK230 is missing FK218 must exist if FK224 exists and FK205 and FK215 and FK222 and FK230 is missing
Person's address continuing	228	Gatuadress2	0-1	Text50		
Person's post number	219	Postnummer	0-1	PostNummer	060, 145, 153	FK219 must exist if FK222 exists and FK 205 and FK230 is missing FK219 must exist if CCYY > 1800 and DD > 60 in FK215 and Fk205 and FK230 is missing FK219 must exist if FK224 exists and FK205 and FK215 and FK222 and FK230 is missing
Person's postal location	220	Postort	0-1	Text50	061, 146, 154	FK220 must exist if FK222 exists and FK 205 and FK230 is missing FK220 must exist if CCYY > 1800 and DD > 60 in FK215 and Fk205 and FK230 is missing FK220 must exist if FK224 exists and FK205 and FK215 and FK222 and FK230 is missing
Country code for postal location	221	LandskodPostort	0-1	Landskod	166	FK221 must exist if FK230 exists
Date of birth	222	Fodelsetid	0-1	Fodelsetid	063	FK222 can not exist if FK215 exists
Other ID number for a legal entity	224	AnnatIDNr	0-1	Text20		

SKV 260 appendix 2	Version: 5.0
XML-struktur	2019-02-21

Term/Field Description	Code	Element name in XML	No.	Type	Controls	
					Id	Description
Name of legal entity	226	OrgNamn	0-1	Text50	065, 151	FK226 can not exist if Fk222 exists, if CC > 17 in FK215, if Fk216 exists or if Fk217 exists FK226 must exist if FK224 exists and FK205, FK215, FK216, FK217 and FK222 is missing
Address in free format	230	FriAdress	0-1	Text350		
Foreign tax identification number (TIN). Other than Swedish.	252	TIN	0-1	Text20	066	FK252 must exist if FK076 exists

6.2.7.2 Element: UppgiftslamnareKU19

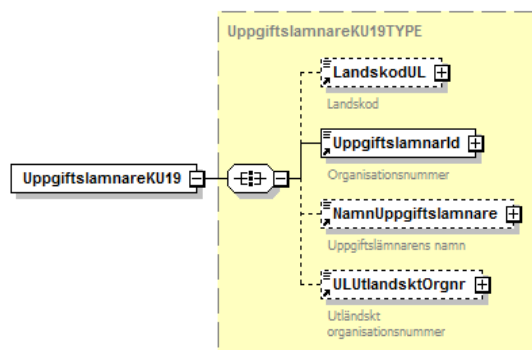

Term/Field Description	Code	Element name in XML	No.	Type	Controls	
					Id	Description
Country code for foreign organization number	075	LandskodUL	0-1	Landskod	043	Fk075 must exist if Fk506 exists
Information provider's organization number	201	UppgiftslamnarId	1	Identitet	053	FK201 can not be equal to FK215
Information provider's name	202	NamnUppgiftslamnare	0-1	Text50		
Information provider's foreign organization number	506	ULUtlandsktOrgnr	0-1	Text13	072	Fk506 must exist if Fk075 exists

SKV 260 appendix 2	Version: 5.0
XML-struktur	2019-02-21

6.2.7.3 *Changes compared to income year 2018 in KU19*

Term/Field		Element name in XML	No.	Type	Controls		Changes
Description	Code				Id	Description	
Insurance agreement number	507	Forsakringsavtalsnummer	0-1	Text30			Removed field

SKV 260 appendix 2	Version: 5.0
XML-struktur	2019-02-21

6.2.8 KU20 – Income statement for interest income

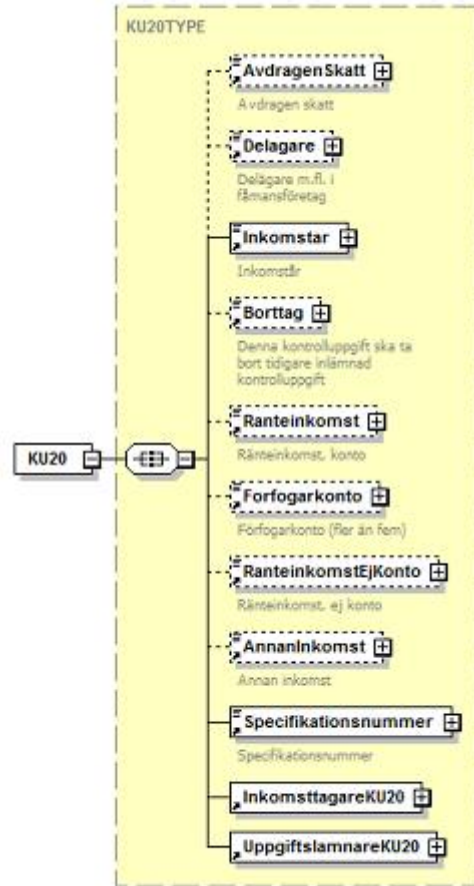

Term/Field					Controls	
Description	Cod e	Element name in XML	No.	Type	Id	Description
Tax deducted	001	AvdragenSkatt	0-1	Belopp10		
Partner	061	Delagare	0-1	Kryss		

SKV 260 appendix 2	Version: 5.0
XML-struktur	2019-02-21

Term/Field Description	Code	Element name in XML	No.	Type	Controls	
					Id	Description
Income year	203	Inkomstar	1	Inkomstar		
Removal	205	Borttag	0-1	Kryss	055	FK205 can only exist if all codes but Fk201, Fk203, Fk570, Fk215, Fk222 and Fk224 are missing
Interest income, account	500	Ranteinkomst	0-1	Belopp10	070	FK500 must exist if Fk205, Fk001, Fk503 and Fk504 are missing
Disposition account	502	Forfogarkonto	0-1	Kryss	071	Fk502 can not exist if Fk503 or Fk504 exists
Interest income, not account	503	RanteinkomstEjKonto	0-1	Belopp10		
Other income	504	AnnanInkomst	0-1	Belopp7		
Specification number	570	Specifikationsnummer	1	SpecifikationsN ummer		
Income earner		InkomsttagareKU20	1	Grp		
Information provider		UppgiftslamnareKU20	1	Grp		

SKV 260 appendix 2	Version: 5.0
XML-struktur	2019-02-21

6.2.8.1 Element: *InkomsttagareKU20*

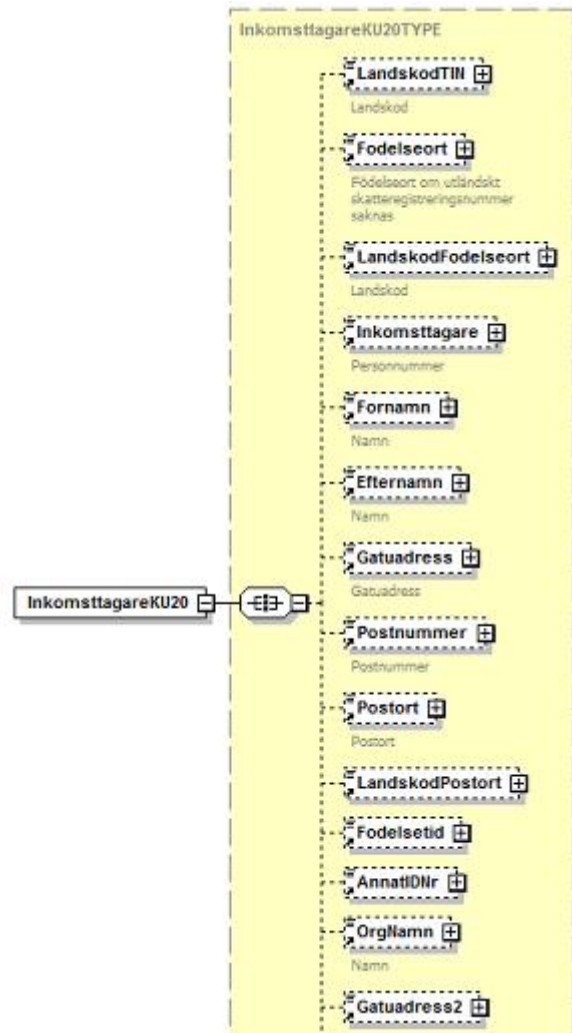

SKV 260 appendix 2	Version: 5.0
XML-struktur	2019-02-21

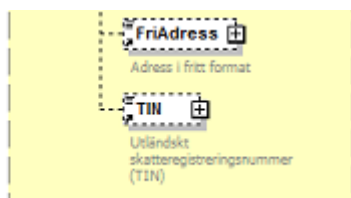

Term/Field		Element name in XML	No.	Type	Controls	
Description	Code				Id	Description
Country code for TIN	076	LandskodTIN	0-1	Landskod	045	FK076 must exist if FK252 exists.
Birthplace	077	Fodlseort	0-1	Text35		
Country code for birthplace	078	LandskodFodlseort	0-1	Landskod	046	FK078 must exist if Fk077 exists.
Personal identity number	215	Inkomsttagare	0-1	Identitet	056	Fk215 must exist if Fk222 and Fk224 are missing.
Person's first name	216	Fornamn	0-1	Text50	057, 142	FK216 must exist if FK222 exists and FK 205 is missing FK216 must exist if CCYY > 1800 and DD > 60 in FK215 and Fk205 is missing
Person's last name	217	Efternamn	0-1	Text50	058, 143	FK217 must exist if FK222 exists and FK 205 is missing FK217 must exist if CCYY > 1800 and DD > 60 in FK215 and Fk205 is missing
Person's address	218	Gatuadress	0-1	Text50	059, 144, 152	FK218 must exist if FK222 exists and FK205 and FK230 is missing FK218 must exist if CCYY > 1800 and DD > 60 in FK215 and Fk205 and FK230 is missing FK218 must exist if FK224 exists and FK205 and FK215 and FK222 and FK230 is missing
Person's address continuing	228	Gatuadress2	0-1	Text50		
Person's post number	219	Postnummer	0-1	PostNummer	060, 145, 153	FK219 must exist if FK222 exists and FK 205 and FK230 is missing FK219 must exist if CCYY > 1800 and DD > 60 in FK215 and Fk205 and FK230 is missing FK219 must exist if FK224 exists and FK205 and FK215 and FK222 and FK230 is missing

SKV 260 appendix 2	Version: 5.0
XML-struktur	2019-02-21

Term/Field Description	Code	Element name in XML	No.	Type	Controls	
					Id	Description
Person's postal location	220	Postort	0-1	Text50	061, 146, 154	FK220 must exist if FK222 exists and FK 205 and FK230 is missing FK220 must exist if CCYY > 1800 and DD > 60 in FK215 and Fk205 and FK230 is missing FK220 must exist if FK224 exists and FK205 and FK215 and FK222 and FK230 is missing
Country code for postal location	221	LandskodPostort	0-1	Landskod	166	FK221 must exist if FK230 exists
Date of birth	222	Fodelsetid	0-1	Fodelsetid	063	FK222 can not exist if FK215 exists
Other ID number for a legal entity	224	AnnatIDNr	0-1	Text20		
Name of legal entity	226	OrgNamn	0-1	Text50	065, 151	FK226 can not exist if Fk222 exists, if CC > 17 in FK215, if Fk216 exists or if Fk217 exists. FK226 must exist if FK224 exists and FK205, FK215, FK216, FK217 and FK222 is missing
Address in free format	230	FriAdress	0-1	Text350		
Foreign tax identification number (TIN). Other than Swedish	252	TIN	0-1	Text20	066	FK252 must exist if FK076 exists

6.2.8.2 Element: UppgiftslamnareKU20

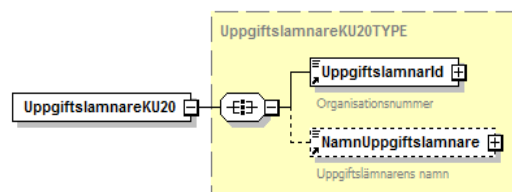

Term/Field Description	Code	Element name in XML	No.	Type	Controls	
					Id	Description
Information provider's organization number	201	UppgiftslamnarlId	1	Identitet	053	FK201 can not be equal to FK215
Information provider's name	202	NamnUppgiftslamnare	0-1	Text50		

SKV 260 appendix 2	Version: 5.0
XML-struktur	2019-02-21

6.2.8.3 *Changes compared to income year 2018 in KU20*

Term/Field Description	Code	Element name in XML	No.	Type	Controls		Changes
					Id	Description	
No changes							

6.2.9 KU21 – Income statement for bonds

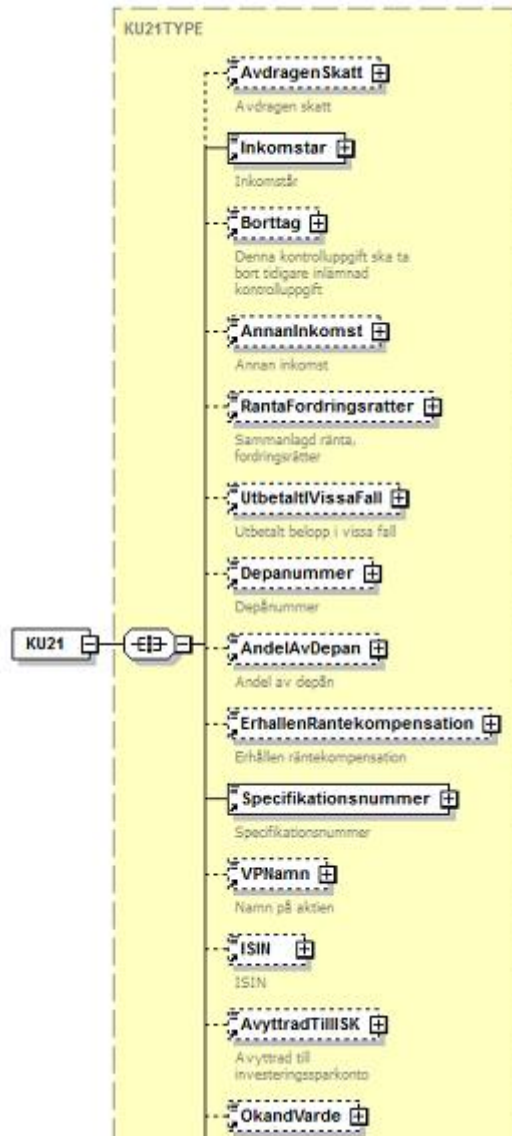

SKV 260 appendix 2	Version: 5.0
XML-struktur	2019-02-21



Term/Field					Controls	
Description	Code	Element name in XML	No.	Type	Id	Description
Tax deducted	001	AvdragenSkatt	0-1	Belopp10		
Tax deducted	203	Inkomstar	1	Inkomstar		
Removal	205	Borttag	0-1	Kryss	055	FK205 can only exist if all codes but Fk201, Fk203, Fk570, Fk215, Fk222 and Fk224 are missing.
Other income	504	AnnanInkomst	0-1	Belopp7		
Total interest, legality of claim	520	RantaFordringsratter	0-1	Belopp10	075	FK520 must exist if Fk205, Fk001, Fk522, Fk504, Fk525 and FK599 are missing.
Paid amount in some cases	522	UtbetaltVissaFall	0-1	Belopp10	167	FK522 cannot exist if FK599 exists.
Deposit number	523	Depanummer	0-1	Belopp12		
Share of the deposit	524	AndelAvDepan	0-1	Decimal2	076	If Fk524 exists, Fk 523 must also exist
Received interest compensation	525	ErhallenRantekomensation	0-1	Belopp10		
Specification number	570	Specifikationsnummer	1	SpecifikationsNummer		
The fund's title	571	VPNamn	0-1	Text50	085, 170	"FK571 must exist if FK572 and FK205 is missing FK571 must exist if (FK572 exist and the two first characters in FK572 are not SE)"
ISIN	572	ISIN	0-1	Isin		
Transferred to investment savings account	573	AvyttradTillISK	0-1	Kryss	086	If FK573 exists must FK522 exist.
Compensation with unknown value	599	OkandVarde	0-1	Kryss		
Income earner		InkomsttagareKU21	1	Grp		
information provider		UppgiftslamnareKU21	1	Grp		

SKV 260 appendix 2	Version: 5.0
XML-struktur	2019-02-21

6.2.9.1 Element: *InkomsttagareKU21*

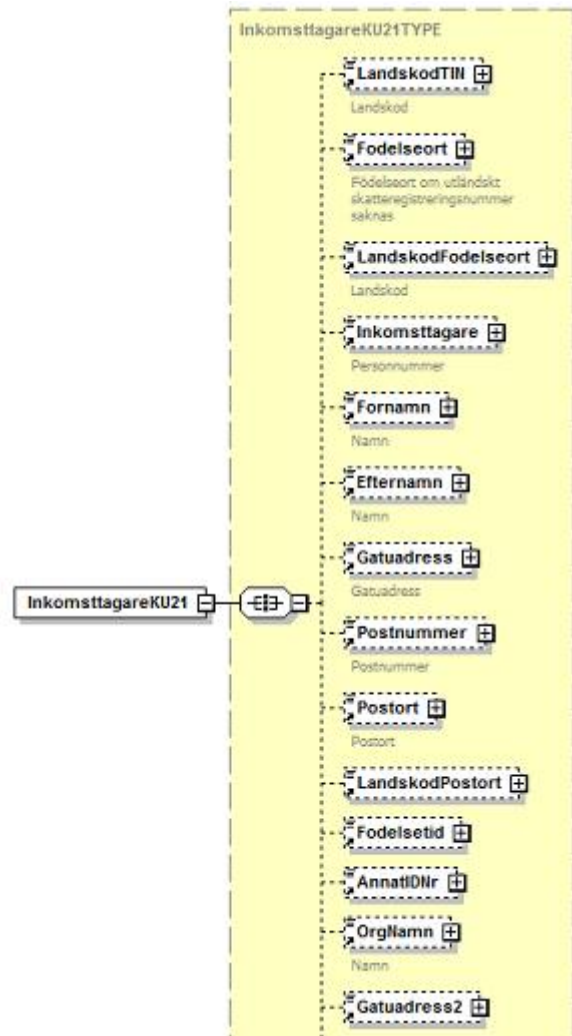

SKV 260 appendix 2	Version: 5.0
XML-struktur	2019-02-21



Term/Field		Element name in XML	No.	Type	Controls	
Description	Code				Id	Description
Country code for TIN	076	LandskodTIN	0-1	Landskod	045	FK076 must exist if FK252 exists.
Birthplace	077	Fodlseort	0-1	Text35		
Country code for birthplace	078	LandskodFodlseort	0-1	Landskod	046	FK078 must exist if Fk077 exists.
Personal identity number	215	Inkomsttagare	0-1	Identitet	056	Fk215 must exist if Fk222 and Fk224 are missing.
Person's first name	216	Fornamn	0-1	Text50	057, 142	FK216 must exist if FK222 exists and FK 205 is missing FK216 must exist if CCYY > 1800 and DD > 60 in FK215 and Fk205 is missing
Person's last name	217	Efternamn	0-1	Text50	058, 143	FK217 must exist if FK222 exists and FK 205 is missing FK217 must exist if CCYY > 1800 and DD > 60 in FK215 and Fk205 is missing
Person's address	218	Gatuadress	0-1	Text50	059, 144, 152	FK218 must exist if FK222 exists and FK 205 and FK230 is missing FK218 must exist if CCYY > 1800 and DD > 60 in FK215 and Fk205 and FK230 is missing FK218 must exist if FK224 exists and FK205 and FK215 and FK222 and FK230 is missing
Person's address continuing	228	Gatuadress2	0-1	Text50		
Person's post number	219	Postnummer	0-1	PostNummer	060, 145, 153	FK219 must exist if FK222 exists and FK 205 and FK230 is missing FK219 must exist if CCYY > 1800 and DD > 60 in FK215 and Fk205 and FK230 is missing FK219 must exist if FK224 exists and FK205 and FK215 and FK222 and FK230 is missing

SKV 260 appendix 2	Version: 5.0
XML-struktur	2019-02-21

Term/Field Description	Code	Element name in XML	No.	Type	Controls	
					Id	Description
Person's postal location	220	Postort	0-1	Text50	061, 146, 154	FK220 must exist if FK222 exists and FK 205 and FK230 is missing FK220 must exist if CCYY > 1800 and DD > 60 in FK215 and Fk205 and FK230 is missing FK220 must exist if FK224 exists and FK205 and FK215 and FK222 and FK230 is missing
Country code for postal location	221	LandskodPostort	0-1	Landskod	166	FK 221 must exist if FK230 exists.
Date of birth	222	Fodelsetid	0-1	Fodelsetid	063	FK222 cannot exist if FK215 exists
Other ID number for a legal entity	224	AnnatIDNr	0-1	Text20		
Name of legal entity	226	OrgNamn	0-1	Text50	065, 151	FK226 can not exist if Fk222 exists, if CC > 17 in FK215, if Fk216 exists or if Fk217 exists. FK226 must exist if FK224 exists and FK205, FK215, FK216, FK217 and FK222 is missing
Address in free format	230	FriAdress	0-1	Text350		
Foreign tax identification number (TIN). Other than Swedish	252	TIN	0-1	Text20	066	FK252 must exist if FK076 exists

6.2.9.2 Element: UppgiftslamnareKU21

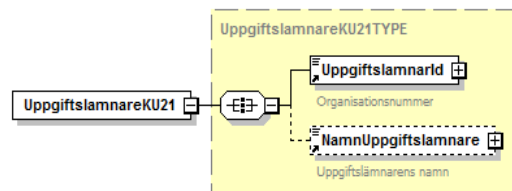

Term/Field Description	Code	Element name in XML	No.	Type	Controls	
					Id	Description
Information provider's organization number	201	UppgiftslamnarId	1	Identitet	053	FK201 can not be equal to FK215
Information provider's name	202	NamnUppgiftslamnare	0-1	Text50		

SKV 260 appendix 2	Version: 5.0
XML-struktur	2019-02-21

6.2.9.3 *Changes compared to income year 2018 in KU21*

Term/Field Description	Code	Element name in XML	No.	Type	Controls		Changes
					Id	Description	
No changes							

SKV 260 appendix 2	Version: 5.0
XML-struktur	2019-02-21

6.2.10 KU25 – Income statement for interest expense

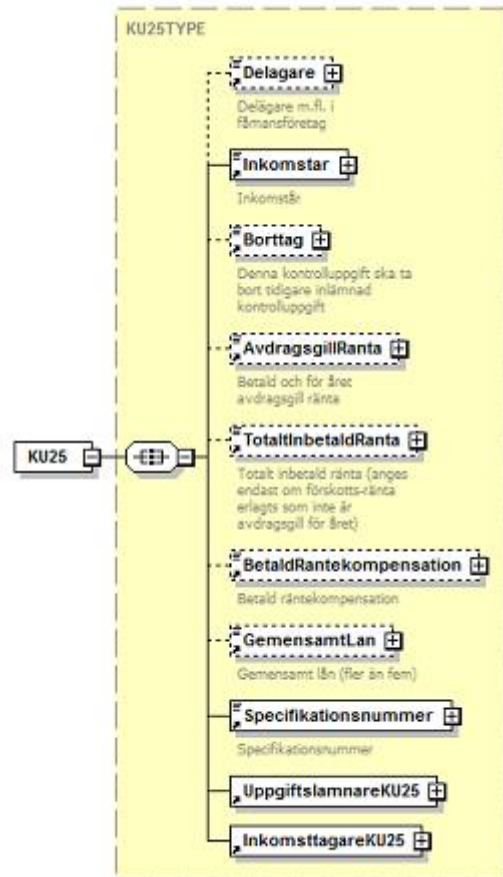

Term/Field Description	Code	Element name in XML	No.	Type	Controls	
					Id	Description
Partner	061	Delagare	0-1	Kryss		
Income year	203	Inkomstar	1	Inkomstar		

SKV 260 appendix 2	Version: 5.0
XML-struktur	2019-02-21

Term/Field Description	Code	Element name in XML	No.	Type	Controls	
					Id	Description
Removal	205	Borttag	0-1	Kryss	055	FK205 can only exist if all codes but Fk201, Fk203, Fk570, Fk215, Fk222 and Fk224 are missing.
Paid and deductible interest for the year	540	AvdragsgillRanta	0-1	Belopp10	081	FK540 must exist if Fk205, Fk541 and Fk543 are missing
Total paid interest	541	TotaltInbetaldRanta	0-1	Belopp10	082	FK541 >= FK540 if Fk541 exists and is greater than zero.
Paid interest compensation	543	BetaldRantekompensation	0-1	Belopp10		
Joint loan	544	GemensamtLan	0-1	Kryss		
Specification number	570	Specifikationsnummer	1	SpecifikationsNummer		
Income earner		InkomsttagareKU25	1	Grp		
information provider		UppgiftslamnareKU25	1	Grp		

SKV 260 appendix 2	Version: 5.0
XML-struktur	2019-02-21

6.2.10.1 Element: InkomstagareKU25

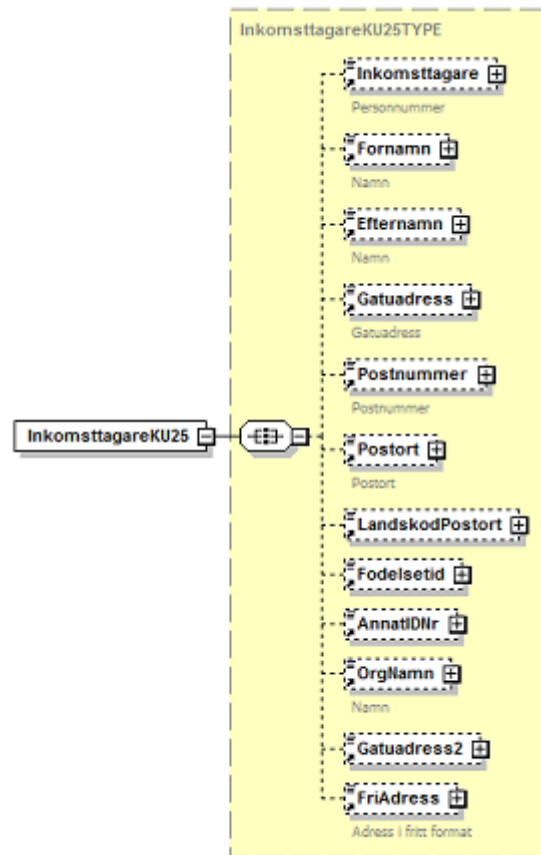

Term/Field					Controls	
Description	Code	Element name in XML	No.	Type	Id	Description
Personal identity number	215	Inkomstagare	0-1	Identitet	056	Fk215 must exist if Fk222 and Fk224 are missing.
Person's first name	216	Fornamn	0-1	Text50	057, 142	FK216 must exist if FK222 exists and FK 205 is missing FK216 must exist if CCYY > 1800 and DD > 60 in FK215 and Fk205 is missing

SKV 260 appendix 2	Version: 5.0
XML-struktur	2019-02-21

Term/Field		Element name in XML	No.	Type	Controls	
Description	Code				Id	Description
Person's last name	217	Efternamn	0-1	Text50	058, 143	FK217 must exist if FK222 exists and FK 205 is missing FK217 must exist if CCYY > 1800 and DD > 60 in FK215 and Fk205 is missing
Person's address	218	Gatuadress	0-1	Text50	059, 144, 152	FK218 must exist if FK222 exists and FK 205 and FK230 is missing FK218 must exist if CCYY > 1800 and DD > 60 in FK215 and Fk205 and FK230 is missing FK218 must exist if FK224 exists and FK205 and FK215 and FK222 and FK230 is missing
Person's address continuing	228	Gatuadress2	0-1	Text50		
Person's post number	219	Postnummer	0-1	PostNummer	060, 145, 153	FK219 must exist if FK222 exists and FK 205 and FK230 is missing FK219 must exist if CCYY > 1800 and DD > 60 in FK215 and Fk205 and FK230 is missing FK219 must exist if FK224 exists and FK205 and FK215 and FK222 and FK230 is missing
Person's postal location	220	Postort	0-1	Text50	061, 146, 154	FK220 must exist if FK222 exists and FK 205 and FK230 is missing FK220 must exist if CCYY > 1800 and DD > 60 in FK215 and Fk205 and FK230 is missing FK220 must exist if FK224 exists and FK205 and FK215 and FK222 and FK230 is missing
Country code for postal location	221	LandskodPostort	0-1	Landskod	166	FK221 must exist if FK230 exists
Date of birth	222	Fodelsetid	0-1	Fodelsetid	063	FK222 can not exist if FK215 exists
Other ID number for a legal entity	224	AnnatIDNr	0-1	Text20		
Name of legal entity	226	OrgNamn	0-1	Text50	065, 151	FK226 can not exist if Fk222 exists, if CC > 17 in FK215, if Fk216 exists or if Fk217 exists. FK226 must exist if FK224 exists and FK205, FK215, FK216, FK217 and FK222 is missing
Address in free format	230	FriAdress	0-1	Text350		

SKV 260 appendix 2	Version: 5.0
XML-struktur	2019-02-21

6.2.10.2 Element: UppgiftslamnareKU25

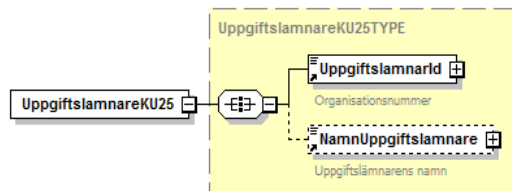

Term/Field		Code	Element name in XML	No.	Type	Controls	
Description	Id					Description	
Information provider's organization number	201	UppgiftslamnarId	1	Identitet	053	FK201 can not be equal to FK215	
Information provider's name	202	NamnUppgiftslamnare	0-1	Text50			

6.2.10.3 Changes compared to income year 2018 in KU25

Term/Field		Code	Element name in XML	No.	Type	Controls		Changes
Description	ID					Description		
No changes								

SKV 260 appendix 2	Version: 5.0
XML-struktur	2019-02-21

6.2.11 KU26 – Income statement for site leasehold fees

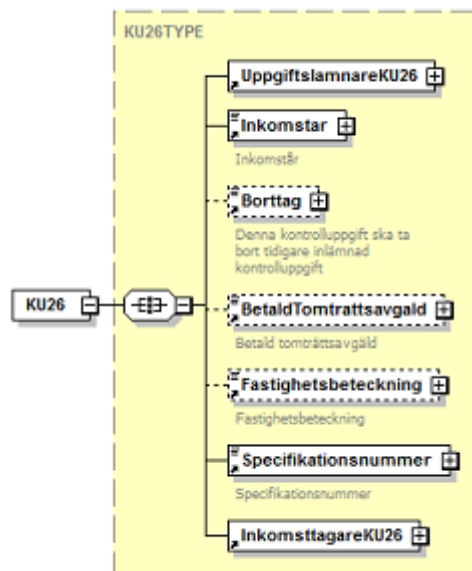

Term/Field					Controls	
Description	Code	Element name in XML	No.	Type	Id	Description
Income year	203	Inkomstar	1	Inkomstar		
Removal	205	Borttag	0-1	Kryss	055	FK205 can only exist if all codes but Fk201, Fk203, Fk570, Fk215, Fk222 and Fk224 are missing.
Paid site leasehold fee	560	BetaldTomtrattsavgald	0-1	Belopp7	083	Fk560 must exist.If FK205 is missing
Property designation	561	Fastighetsbeteckning	0-1	Text36	084	Fk561 must exist.If FK205 is missing
Specification number	570	Specifikationsnummer	1	SpecifikationsNummer		
Income earner		InkomsttagareKU26	1	Grp		
Information provider		UppgiftslamnareKU26	1	Grp		

SKV 260 appendix 2	Version: 5.0
XML-struktur	2019-02-21

6.2.11.1 Element: *InkomsttagareKU26*

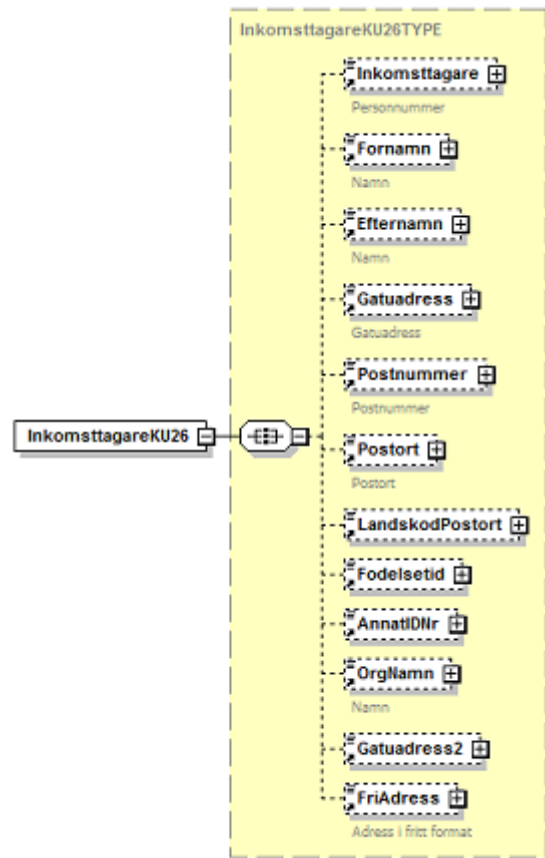

SKV 260 appendix 2	Version: 5.0
XML-struktur	2019-02-21

Term/Field		Element name in XML	No.	Type	Controls	
Description	Code				Id	Description
Personal identity number	215	Inkomsttagare	0-1	Identitet	056	Fk215 must exist if Fk222 and Fk224 are missing.
Person's first name	216	Fornamn	0-1	Text50	057, 142	FK216 must exist if FK222 exists and FK 205 is missing FK216 must exist if CCYY > 1800 and DD > 60 in FK215 and Fk205 is missing
Person's last name	217	Efternamn	0-1	Text50	058, 143	FK217 must exist if FK222 exists and FK 205 is missing FK217 must exist if CCYY > 1800 and DD > 60 in FK215 and Fk205 is missing
Person's address	218	Gatuadress	0-1	Text50	059, 144, 152	FK218 must exist if FK222 exists and FK 205 and Fk230 is missing FK218 must exist if CCYY > 1800 and DD > 60 in FK215 and Fk205 and Fk230 is missing FK218 must exist if FK224 exists and FK205 and FK215 and FK222 and Fk230 is missing
Person's address continuing	228	Gatuadress2	0-1	Text50		
Person's post number	219	Postnummer	0-1	PostNummer	060, 145, 153	FK219 must exist if FK222 exists and FK 205 and Fk230 is missing FK219 must exist if CCYY > 1800 and DD > 60 in FK215 and Fk205 and Fk230 is missing FK219 must exist if FK224 exists and FK205 and FK215 and FK222 and Fk230 is missing
Person's postal location	220	Postort	0-1	Text50	061, 146, 154	FK220 must exist if FK222 exists and FK 205 and Fk230 is missing FK220 must exist if CCYY > 1800 and DD > 60 in FK215 and Fk205 and Fk230 is missing FK220 must exist if FK224 exists and FK205 and FK215 and FK222 and Fk230 is missing
Country code for postal location	221	LandskodPostort	0-1	Landskod	166	FK221 must exist if FK230 exists
Date of birth	222	Fodelsetid	0-1	Fodelsetid	063	FK222 can not exist if FK215 exists
Other ID number for a legal entity	224	AnnatIDNr	0-1	Text20		
Name of legal entity	226	OrgNamn	0-1	Text50	065, 151	FK226 can not exist if Fk222 exists, if CC > 17 in FK215, if Fk216 exists or if Fk217 exists. FK226 must exist if FK224 exists and FK205, FK215, FK216, FK217 and FK222 is missing

SKV 260 appendix 2	Version: 5.0
XML-struktur	2019-02-21

Term/Field Description	Code	Element name in XML	No.	Type	Controls	
					Id	Description
Address in free format	230	FriAdress	0-1	Text350		

6.2.11.2 Element: UppgiftslamnareKU26

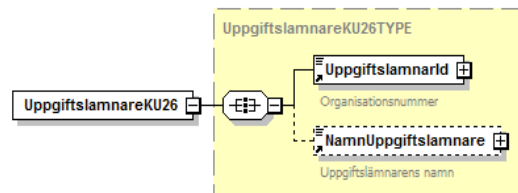

Term/Field Description	Code	Element name in XML	No.	Type	Controls	
					Id	Description
Information provider's organization number	201	UppgiftslamnarId	1	Identitet	053	FK201 can not be equal to FK215
Information provider's name	202	NamnUppgiftslamnare	0-1	Text50		

6.2.11.3 Changes compared to income year 2018 in KU26

Term/Field Description	Code	Element name in XML	No.	Type	Controls		Changes
					Id	Description	
No changes							

SKV 260 appendix 2	Version: 5.0
XML-struktur	2019-02-21

6.2.12 KU28 – Income statement for private investors tax relief

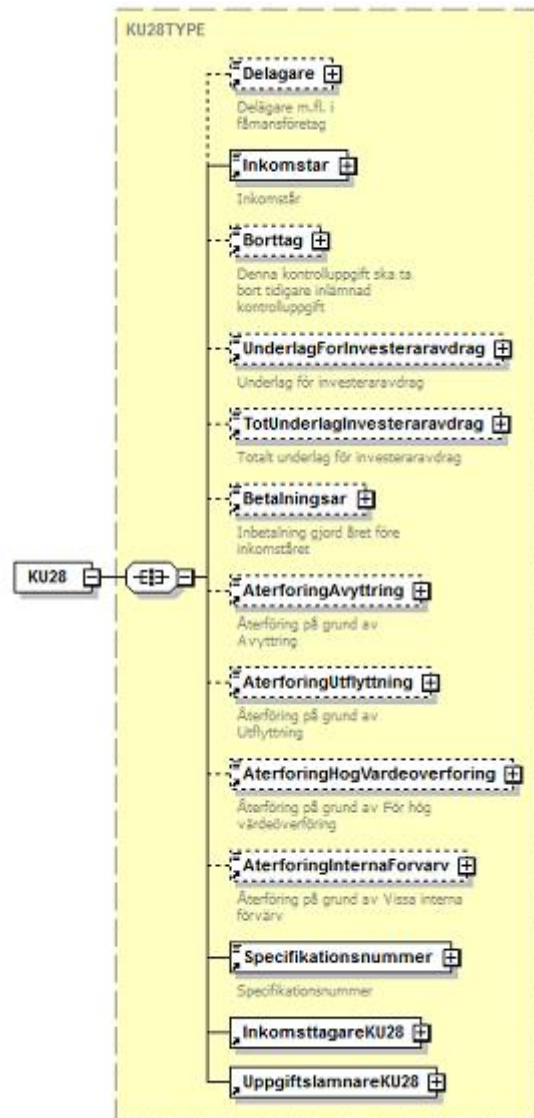

SKV 260 appendix 2	Version: 5.0
XML-struktur	2019-02-21

Term/Field Description	Code	Element name in XML	No.	Type	Controls	
					Id	Description
Partner	061	Delagare	0-1	Kryss		
Income year	203	Inkomstar	1	Inkomstar		
Removal	205	Borttag	0-1	Kryss	055	Fk205 can only exist if all codes but Fk201, Fk203, Fk570, Fk215, Fk222 and Fk224 are missing.
Basis for Investors Deduction	528	UnderlagForInvesteraravdrag	0-1	Belopp10	077, 135	Fk528 must exist if Fk529 exists. Fk528 <= Fk529.
Total Basis for Investors Deduction	529	TotUnderlagInvesteraravdrag	0-1	Belopp10	136, 137	Fk529 must exist if Fk528 exists. Fk529 >= Fk528.
Payment year	530	Betalningsar	0-1	Kryss	164	Fk530 can not exist if Fk528 is missing.
Reversal due to sale	531	AterforingAvyttring	0-1	Kryss	080, 078, 079	Fk531 can not exist if FK528 exists. Fk531 can not exist if FK529 exists. FK531 can not exist if FK530 exists.
Reversal due to moving abroad	532	AterforingUtflytning	0-1	Kryss	147, 155, 158	Fk532 can not exist if FK528 exists. Fk532 can not exist if FK529 exists. Fk532 can not exist if FK530 exists.
Reversal due to too high distribution	533	AterforingHogVardeoverforing	0-1	Kryss	148, 156, 159	Fk533 can not exist if FK528 exists. Fk533 can not exist if FK529 exists. Fk533 can not exist if FK530 exists.
Reversal due to certain internal acquisitions	534	AterforingInternaForvarv	0-1	Kryss	149, 157, 160	Fk534 can not exist if FK528 exists. Fk534 can not exist if FK529 exists. Fk534 can not exist if FK530 exists.
Specification number	570	Specifikationsnummer	1	SpecifikationsN ummer		
Income earner		InkomsttagareKU28	1	Grp		
information provider		UppgiftslamnareKU28	1	Grp		

SKV 260 appendix 2	Version: 5.0
XML-struktur	2019-02-21

6.2.12.1 Element: *InkomsttagareKU28*

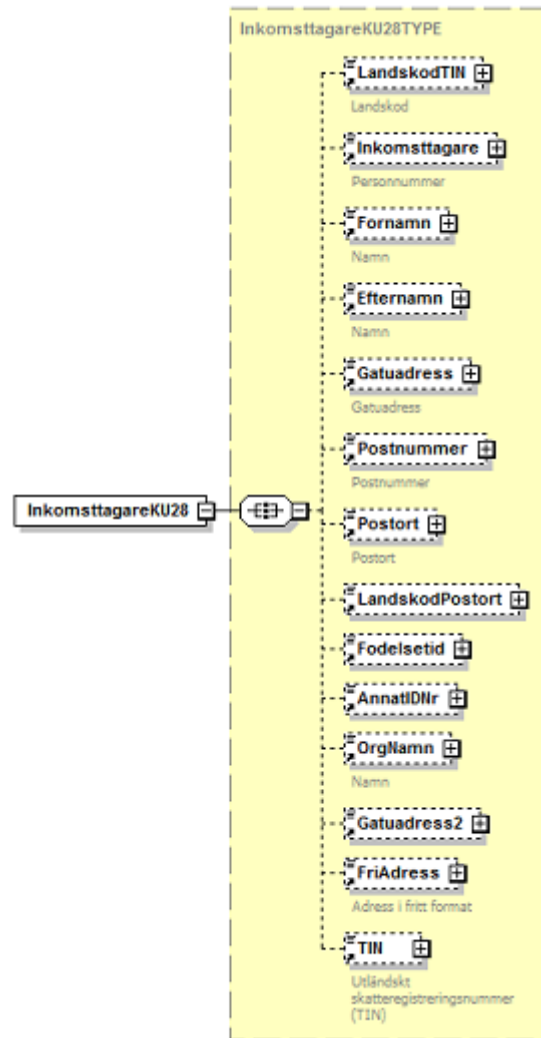

SKV 260 appendix 2	Version: 5.0
XML-struktur	2019-02-21

Term/Field Description	Code	Element name in XML	No.	Type	Controls	
					Id	Description
Country code for TIN	076	LandskodTIN	0-1	Landskod	045	FK076 must exist if FK252 exists.
Personal identity number	215	Inkomsttagare	0-1	Identitet	056	Fk215 must exist if Fk222 and Fk224 are missing.
Person's first name	216	Fornamn	0-1	Text50	057, 142	FK216 must exist if FK222 exists and FK 205 is missing FK216 must exist if CCYY > 1800 and DD > 60 in FK215 and Fk205 is missing
Person's last name	217	Efternamn	0-1	Text50	058, 143	FK217 must exist if FK222 exists and FK 205 is missing FK217 must exist if CCYY > 1800 and DD > 60 in FK215 and Fk205 is missing
Person's address	218	Gatuadress	0-1	Text50	059, 144, 152	FK218 must exist if FK222 exists and FK 205 and FK230 is missing FK218 must exist if CCYY > 1800 and DD > 60 in FK215 and Fk205 and FK230 is missing FK218 must exist if FK224 exists and FK205 and FK215 and FK222 and FK230 is missing
Person's address continuing	228	Gatuadress2	0-1	Text50		
Person's post number	219	Postnummer	0-1	PostNummer	060, 145, 153	FK219 must exist if FK222 exists and FK 205 and FK230 is missing FK219 must exist if CCYY > 1800 and DD > 60 in FK215 and Fk205 and FK230 is missing FK219 must exist if FK224 exists and FK205 and FK215 and FK222 and FK230 is missing
Person's postal location	220	Postort	0-1	Text50	061, 146, 154	FK220 must exist if FK222 exists and FK 205 and FK230 is missing FK220 must exist if CCYY > 1800 and DD > 60 in FK215 and Fk205 and FK230 is missing FK220 must exist if FK224 exists and FK205 and FK215 and FK222 and FK230 is missing
Country code for postal location	221	LandskodPostort	0-1	Landskod	166	FK221 must exist if FK230 exists.
Date of birth	222	Fodelsetid	0-1	Fodelsetid	063	FK222 can not exist if FK215 exists
Other ID number for a legal entity	224	AnnatIDNr	0-1	Text20		

SKV 260 appendix 2	Version: 5.0
XML-struktur	2019-02-21

Term/Field Description	Code	Element name in XML	No.	Type	Controls	
					Id	Description
Name of legal entity	226	OrgNamn	0-1	Text50	065, 151	FK226 can not exist if Fk222 exists, if CC > 17 in FK215, if Fk216 exists or if Fk217 exists. FK226 must exist if FK224 exists and FK205, FK215, FK216, FK217 and FK222 is missing
Address in free format	230	FriAdress	0-1	Text350		
Foreign tax identification number (TIN). Other than Swedish	252	TIN	0-1	Text20	066	FK252 must exist if FK076 exists

6.2.12.2 Element: UppgiftslamnareKU28

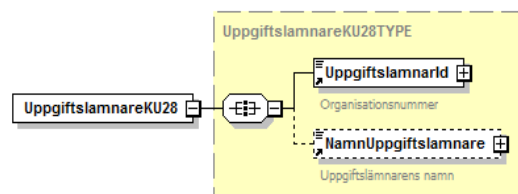

Term/Field Description	Code	Element name in XML	No.	Type	Controls	
					Id	Description
Information provider's organization number	201	UppgiftslamnarId	1	Identitet	053	FK201 can not be equal to FK215
Information provider's name	202	NamnUppgiftslamnare	0-1	Text50		

6.2.12.3 Changes compared to income year 2018 in KU28

Term/Field Description	Code	Elementname in XML	No.	Type	Controls		Changes
					Id	Description	
No changes							

SKV 260 appendix 2	Version: 5.0
XML-struktur	2019-02-21

6.2.13 KU30 – Income statement for investment savings account – standard income

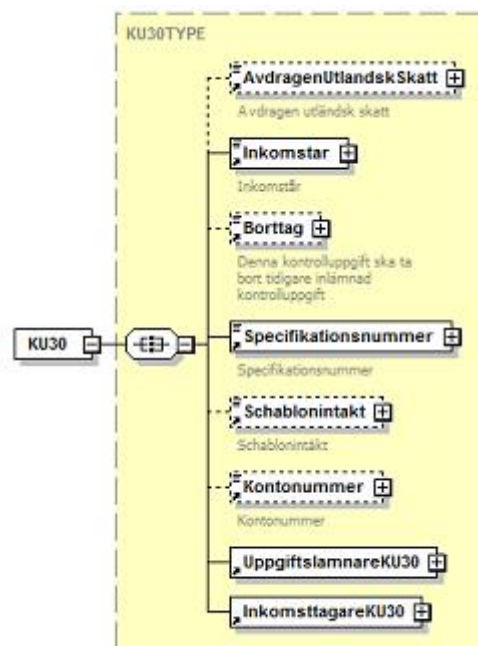

Term/Field	Code	Element name in XML	No.	Type	Controls	
					Id	Description
Foreign tax deducted	002	AvdragenUtlandsSkatt	0-1	Belopp10		
Income year	203	Inkomstar	1	Inkomstar		
Removal	205	Borttag	0-1	Kryss	055	FK205 can only exist if all codes but Fk201, Fk203, Fk570, Fk215, Fk222 and Fk224 are missing.
Specification number	570	Specifikationsnummer	1	SpecifikationsNummer		
Standard income	815	Schablonintakt	0-1	Belopp10	133	Fk815 must exist if FK205 is missing
Number of account	817	Kontonummer	0-1	Text30		

SKV 260 appendix 2	Version: 5.0
XML-struktur	2019-02-21

Term/Field Description	Code	Element name in XML	No.	Type	Controls	
					Id	Description
Income earner		UppgiftslamnareKU30	1	Grp		
Information provider		InkomsttagareKU30	1	Grp		

6.2.13.1 Element: InkomsttagareKU30

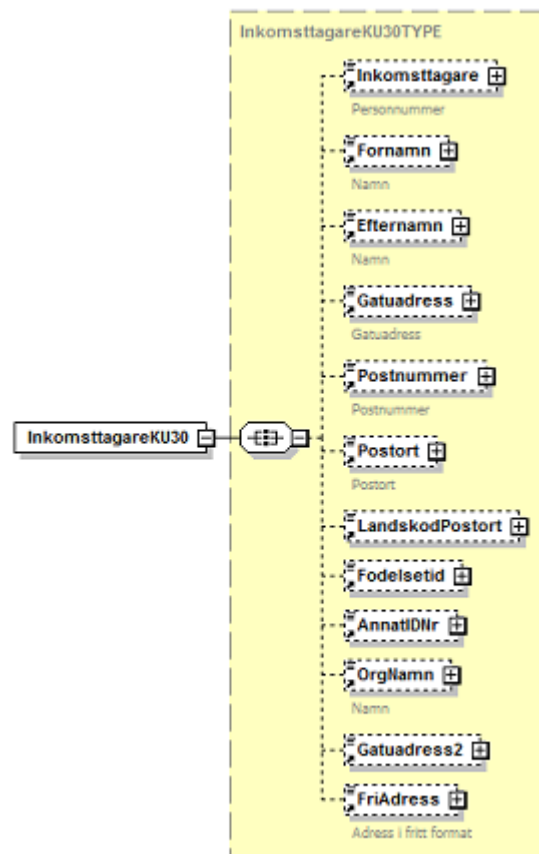

SKV 260 appendix 2	Version: 5.0
XML-struktur	2019-02-21

Term/Field Description	Code	Element name in XML	No.	Type	Controls	
					Id	Description
Personal identity number	215	Inkomsttagare	0-1	Identitet	056	Fk215 must exist if Fk222 and Fk224 are missing.
Persons's first name	216	Fornamn	0-1	Text50	057, 142	FK216 must exist if FK222 exists and 205 are missing. FK216 must exist if CCYY > 1800 and DD > 60 in FK215 and Fk205 is missing
Person's last name	217	Efternamn	0-1	Text50	058, 143	FK217 must exist if FK222 exists and 205 is missing. FK217 must exist if CCYY > 1800 and DD > 60 in FK215 and Fk205 is missing
Person's address	218	Gatuadress	0-1	Text50	059, 144, 152	FK218 must exist if FK222 exists and FK 205 and FK230 is missing FK218 must exist if CCYY > 1800 and DD > 60 in FK215 and Fk205 and FK230 is missing FK218 must exist if FK224 exists and FK205 and FK215 and FK222 and FK230 is missing
Person's address continuing	228	Gatuadress2	0-1	Text50		
Person's post number	219	Postnummer	0-1	PostNummer	060, 145, 153	FK219 must exist if FK222 exists and FK 205 and FK230 is missing FK219 must exist if CCYY > 1800 and DD > 60 in FK215 and Fk205 and FK230 is missing FK219 must exist if FK224 exists and FK205 and FK215 and FK222 and FK230 is missing
Person's postal location	220	Postort	0-1	Text50	061, 146, 154	FK220 must exist if FK222 exists and FK 205 and FK230 is missing FK220 must exist if CCYY > 1800 and DD > 60 in FK215 and Fk205 and FK230 is missing FK220 must exist if FK224 exists and FK205 and FK215 and FK222 and FK230 is missing
Country code for postal location	221	LandskodPostort	0-1	Landskod	166	FK221 must exist if FK230 exists.
Date of birth	222	Fodelsetid	0-1	Fodelsetid	063	FK222 can not exist if FK215 exists
Other ID number for a legal entity	224	AnnatIDNr	0-1	Text20		
Name of legal entity	226	OrgNamn	0-1	Text50	065, 151	FK226 can not exist if Fk222 exists, if CC > 17 in FK215, if Fk216 exists or if Fk217 exists. FK226 must exist if FK224 exists and FK205 and FK215, FK216, FK217 and FK222 is missing
Address in free format	230	FriAdress	0-1	Text350		

SKV 260 appendix 2	Version: 5.0
XML-struktur	2019-02-21

6.2.13.2 Element: UppgiftslamnareKU30

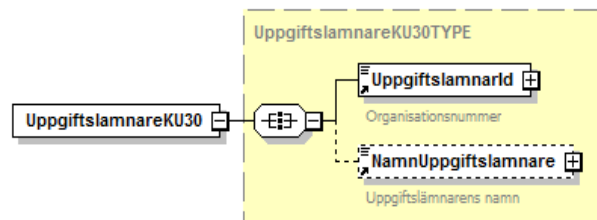

Term/Field		Code	Element name in XML	No.	Type	Controls	
Description	Id					Description	
Information provider's organization number	201	UppgiftslamnarId	1	Identitet	053	FK201 can not be equal to FK215	
Information provider's name	202	NamnUppgiftslamnare	0-1	Text50			

6.2.13.3 Changes compared to income year 2018 in KU30

Term/ Field		Code	Element name in XML	No.	Type	Controls		Changes
Description	Id					Description		
No changes								

SKV 260 appendix 2	Version: 5.0
XML-struktur	2019-02-21

6.2.14 KU31 – Income statement for dividends etc for shares and other securities

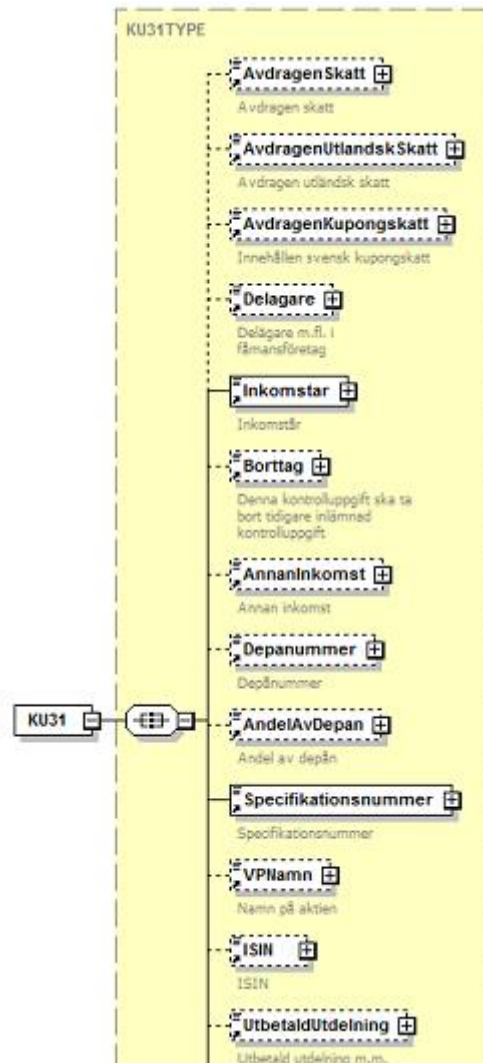

SKV 260 appendix 2	Version: 5.0
XML-struktur	2019-02-21

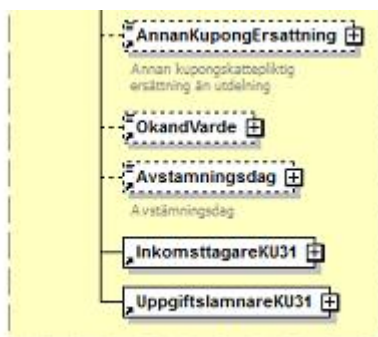

Term/Field		Code	Element name in XML	No.	Type	Controls	
Description	Id					Description	
Tax deducted	001	AvdragenSkatt	0-1	Belopp10			
Foreign tax deducted	002	AvdragenUtlandskSkatt	0-1	Belopp10	005	FK002 <=(Fk574+Fk504)	
Swedish withholding tax on dividend	003	AvdragenKupongskatt	0-1	Belopp10	006, 134, 150	FK003 <= FK574 if FK574 exists. Fk003 can not exist if Fk001 and/or Fk002 exist. FK003 <= FK581 if FK581 exists.	
Partner	061	Delagare	0-1	Kryss			
Income year	203	Inkomstar	1	Inkomstar			
Removal	205	Borttag	0-1	Kryss	055	FK205 can only exist if all codes but Fk201, Fk203, Fk570, Fk215, Fk222 and Fk224 are missing.	
Other income	504	AnnanInkomst	0-1	Belopp7			
Deposit number	523	Depanummer	0-1	Belopp12			
Share of the deposit	524	AndelAvDepan	0-1	Decimal2	076	If Fk524 exists, Fk 523 must also exist	
Specification number	570	Specifikationsnummer	1	SpecifikationsNummer			
The fund's title	571	VPNamn	0-1	Text50	085, 170	FK571 must exist if FK572 is missing and FK205 is missing. FK571 must exist if (FK572 exist and the two first characters in FK572 are not SE).	
ISIN	572	ISIN	0-1	Isin			

SKV 260 appendix 2	Version: 5.0
XML-struktur	2019-02-21

Term/Field Description	Code	Element name in XML	No.	Type	Controls	
					Id	Description
Paid dividend	574	UtbetalUtdelning	0-1	Belopp10	088, 168	FK574 must exist if Fk205, Fk001, Fk504, Fk581 and FK599 are missing. FK574 cannot exist if FK599 exists.
Other received compensation taxable for Swedish withholding tax	581	AnnanKupongErsattning	0-1	Belopp10	092	Fk581 can not exist if Fk574 exists.
Compensation with unknown value	599	OkandVarde	0-1	Kryss		
Record date	853	Avstamningsdag	0-1	Datum		
Income earner		InkomsttagareKU31	1	Grp		
Information provider		UppgiftslamnareKU31	1	Grp		

SKV 260 appendix 2	Version: 5.0
XML-struktur	2019-02-21

6.2.14.1 Element: *InkomsttagareKU31*

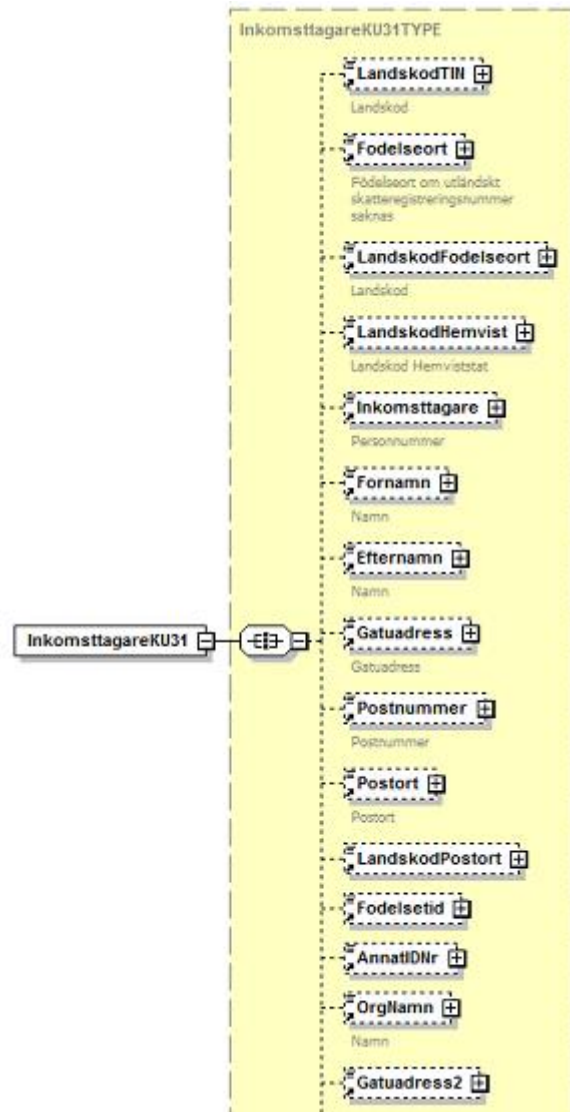

SKV 260 appendix 2	Version: 5.0
XML-struktur	2019-02-21



Term/Field		Element name in XML	No.	Type	Controls	
Description	Code				Id	Description
Country code for TIN	076	LandskodTIN	0-1	Landskod	045	FK076 must exist if FK252 exists.
Birthplace	077	Fodelseort	0-1	Text35		
Country code for birthplace	078	LandskodFodelseort	0-1	Landskod	046	FK078 must exist if Fk077 exists.
Code for country of residence	079	LandskodHemvist	0-1	Landskod		
Personal identity number	215	Inkomsttagare	0-1	Identitet	056	Fk215 must exist if Fk222 and Fk224 are missing.
Person's first name	216	Fornamn	0-1	Text50	057, 142	FK216 must exist if FK222 exists and FK 205 is missing FK216 must exist if CCYY > 1800 and DD > 60 in FK215 and Fk205 is missing
Person's last name	217	Efternamn	0-1	Text50	058, 143	FK217 must exist if FK222 exists and FK 205 is missing FK217 must exist if CCYY > 1800 and DD > 60 in FK215 and Fk205 is missing
Person's address	218	Gatuadress	0-1	Text50	059, 144, 152	FK218 must exist if FK222 exists and FK 205 and FK230 is missing FK218 must exist if CCYY > 1800 and DD > 60 in FK215 and Fk205 and FK230 is missing FK218 must exist if FK224 exists and FK205 and FK215 and FK222 and FK230 is missing
Person's address continuing	228	Gatuadress2	0-1	Text50		
Person's post number	219	Postnummer	0-1	PostNummer	060, 145, 153	FK219 must exist if FK222 exists and FK 205 and FK230 is missing FK219 must exist if CCYY > 1800 and DD > 60 in FK215 and Fk205 and FK230 is missing FK219 must exist if FK224 exists and FK205 and FK215 and FK222 and FK230 is missing

SKV 260 appendix 2	Version: 5.0
XML-struktur	2019-02-21

Term/Field Description	Code	Element name in XML	No.	Type	Controls	
					Id	Description
Person's postal location	220	Postort	0-1	Text50	061, 146, 154	FK220 must exist if FK222 exists and FK 205 and FK230 is missing FK220 must exist if CCYY > 1800 and DD > 60 in FK215 and Fk205 and FK230 is missing FK220 must exist if FK224 exists and FK205 and FK215 and FK222 and FK230 is missing
Country code for postal location	221	LandskodPostort	0-1	Landskod	166	FK221 must exist if FK230 exists.
Date of birth	222	Fodelsetid	0-1	Fodelsetid	063	FK222 can not exist if FK215 exists
Other ID number for a legal entity	224	AnnatIDNr	0-1	Text20		
Name of legal entity	226	OrgNamn	0-1	Text50	065, 151	FK226 can not exist if Fk222 exists, if CC > 17 in FK215, if Fk216 exists or if Fk217 exists. FK226 must exist if FK224 exists and FK205 and FK215, FK216, FK217 and FK222 is missing
Address in free format	230	FriAdress	0-1	Text350		
Foreign tax identification number (TIN). Other than Swedish	252	TIN	0-1	Text20	066	FK252 must exist if FK076 exists

6.2.14.2 Element: UppgiftslamnareKU31

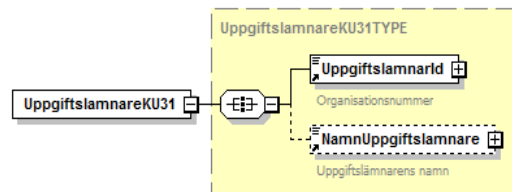

Term/Field Description	Code	Element name in XML	No.	Type	Controls	
					Id	Description
Information provider's organization number	201	UppgiftslamnarId	1	Identitet	053	FK201 can not be equal to FK215
Information provider's name	202	NamnUppgiftslamnare	0-1	Text50		

SKV 260 appendix 2	Version: 5.0
XML-struktur	2019-02-21

6.2.14.3 Changes compared to income year 2018 in KU31

Term/Field Description	Code	Element name in XML	No.	Type	Controls		Changes
					Id	Description	
No changes							

SKV 260 appendix 2	Version: 5.0
XML-struktur	2019-02-21

6.2.15 KU32 – Income statement for transfer of shares, bonds and other securities

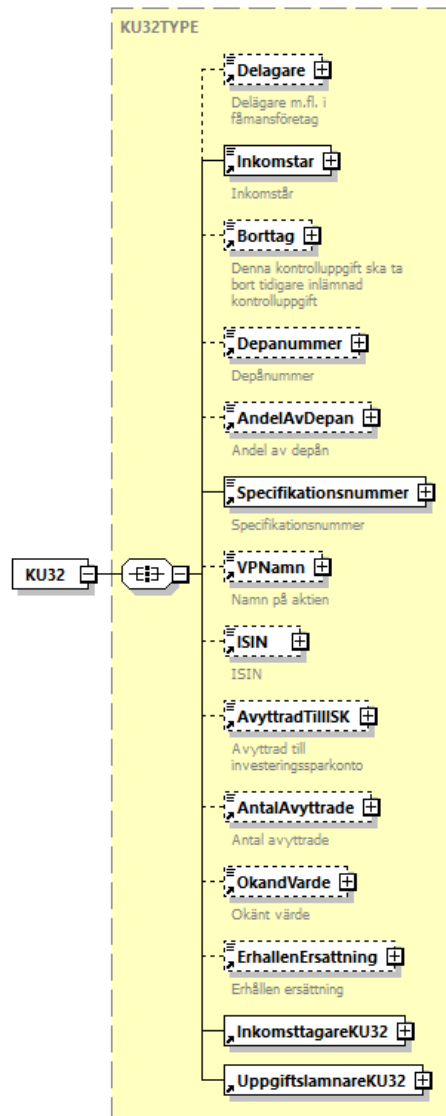

SKV 260 appendix 2	Version: 5.0
XML-struktur	2019-02-21

Term/Field Description	Code	Element name in XML	No.	Type	Controls	
					Id	Description
Partner	061	Delagare	0-1	Kryss		
Income year	203	Inkomstar	1	Inkomstar		
Removal	205	Borttag	0-1	Kryss	055	FK205 can only exist if all codes but Fk201, Fk203, Fk570, Fk215, Fk222 and Fk224 are missing.
Deposit number	523	Depanummer	0-1	Belopp12		
Share of the deposit	524	AndelAvDepan	0-1	Decimal2	076	If Fk524 exists, Fk523 must also exist
Specification number	570	Specifikationsnummer	1	SpecifikationsNummer		
The fund's title	571	VPNamn	0-1	Text50	085, 170	FK571 must exist if FK572 is missing and FK205 is missing. FK571 must exist if (FK572 exist and the two first characters in FK572 are not SE.
ISIN	572	ISIN	0-1	Isin		
Transferred to investment savings account	573	AvyttradTillISK	0-1	Kryss		
Number transferred (Sold or redeemed)	576	AntalAvytrade	0-1	Belopp12	089	Fk576 must exist if FK205 is missing.
Compensation with unknown value	599	OkandVarde	0-1	Kryss		
Received compensation	810	ErhallenErsattning	0-1	Belopp10	090, 169	Fk810 must exist if FK205 and FK599 are missing. FK810 cannot exist if F599 exists,
Income earner		InkomsttagareKU32	1	Grp		
Information provider		UppgiftslamnareKU32	1	Grp		

SKV 260 appendix 2	Version: 5.0
XML-struktur	2019-02-21

6.2.15.1 Element: *InkomsttagareKU32*

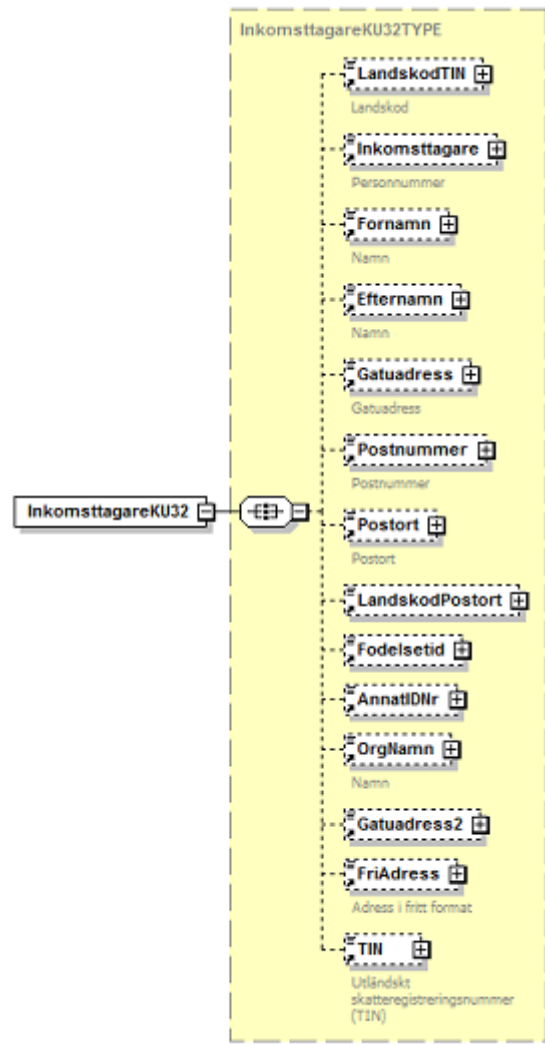

SKV 260 appendix 2	Version: 5.0
XML-struktur	2019-02-21

Term/Field Description	Code	Element name in XML	No.	Type	Controls	
					Id	Description
Country code TIN	076	LandskodTIN	0-1	Landskod	045	FK076 must exist if FK252 exists.
Personal identity number	215	Inkomsttagare	0-1	Identitet	056	Fk215 must exist if Fk222 and Fk224 are missing.
Person's first name	216	Fornamn	0-1	Text50	057, 142	FK216 must exist if FK222 exists and FK 205 is missing FK216 must exist if CCYY > 1800 and DD > 60 in FK215 and Fk205 is missing
Person's last name	217	Efternamn	0-1	Text50	058, 143	FK217 must exist if FK222 exists and FK 205 is missing FK217 must exist if CCYY > 1800 and DD > 60 in FK215 and Fk205 is missing
Person's address	218	Gatuadress	0-1	Text50	059, 144, 152	FK218 must exist if FK222 exists and FK 205 and FK230 is missing FK218 must exist if CCYY > 1800 and DD > 60 in FK215 and Fk205 and FK230 is missing FK218 must exist if FK224 exists and FK205 and FK215 and FK222 and FK230 is missing
Person's address continuing	228	Gatuadress2	0-1	Text50		
Person's post number	219	Postnummer	0-1	PostNummer	060, 145, 153	FK219 must exist if FK222 exists and FK 205 and FK230 is missing FK219 must exist if CCYY > 1800 and DD > 60 in FK215 and Fk205 and FK230 is missing FK219 must exist if FK224 exists and FK205 and FK215 and FK222 and FK230 is missing
Person's postal location	220	Postort	0-1	Text50	061, 146, 154	FK220 must exist if FK222 exists and FK 205 and FK230 is missing FK220 must exist if CCYY > 1800 and DD > 60 in FK215 and Fk205 and FK230 is missing FK220 must exist if FK224 exists and FK205 and FK215 and FK222 and FK230 is missing
Country code for postal location	221	LandskodPostort	0-1	Landskod	166	FK221 must exist if FK230 exists
Date of birth	222	Fodelsetid	0-1	Fodelsetid	063	FK222 can not exist if FK215 exists
Other ID number for a legal entity	224	AnnatIDNr	0-1	Text20		

SKV 260 appendix 2	Version: 5.0
XML-struktur	2019-02-21

Term/Field Description	Code	Element name in XML	No.	Type	Controls	
					Id	Description
Name of legal entity	226	OrgNamn	0-1	Text50	065, 151	FK226 can not exist if Fk222 exists, if CC > 17 in FK215, if Fk216 exists or if Fk217 exists. FK226 must exist if FK224 exists and FK205 and FK215, FK216, FK217 and FK222 is missing
Address in free format	230	FriAdress	0-1	Text350		
Foreign tax identification number (TIN). Other than Swedish	252	TIN	0-1	Text20	066	FK252 must exist if FK076 exists

6.2.15.2 Element: UppgiftslamnareKU32

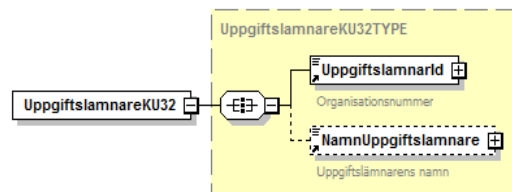

Term/Field Description	Code	Element name in XML	No.	Type	Controls	
					Id	Description
Information provider's organization number	201	UppgiftslamnarId	1	Identitet	053	FK201 can not be equal to FK215
Information provider's name	202	NamnUppgiftslamnare	0-1	Text50		

6.2.15.3 Changes compared to income year 2018 in KU32

Term/Field Description	Code	Element name in XML	No.	Type	Controls		Changes
					Id	Description	
No changes							

SKV 260 appendix 2	Version: 5.0
XML-struktur	2019-02-21

6.2.16 KU34 – Income statement for the transfer/issuance/completion of options

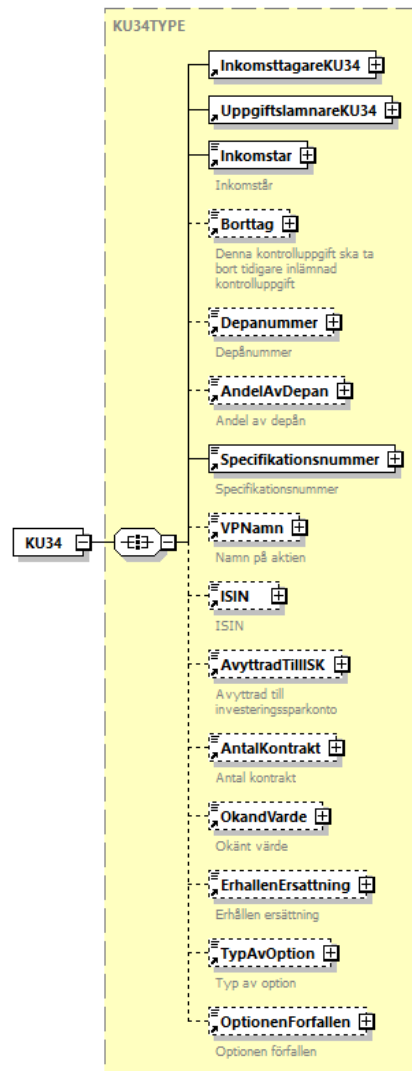

SKV 260 appendix 2	Version: 5.0
XML-struktur	2019-02-21

Term/Field Description	Code	Element name in XML	No.	Type	Controls	
					Id	Description
Income year	203	Inkomstar	1	Inkomstar		
Removal	205	Borttag	0-1	Kryss	055	FK205 can only exist if all codes but Fk201, Fk203, Fk570, Fk215, Fk222 and Fk224 are missing.
Deposit number	523	Depanummer	0-1	Belopp12		
Share of the deposit	524	AndelAvDepan	0-1	Decimal2	076	If Fk524 exists, Fk 523 must also exist
Specification number	570	Specifikationsnummer	1	SpecifikationsNummer		
The fund's title	571	VPNamn	0-1	Text50	085, 170	"FK571 must exist if FK572 and FK205 is missing FK571 must exist if (FK572 exist and the two first characters in FK572 are not SE)"
ISIN	572	ISIN	0-1	Isin		
Transferred to investment savings account	573	AvyttradTillISK	0-1	Kryss	087	FK573 cannot exist if FK813 exists.
Number of contracts	578	AntalKontrakt	0-1	Belopp10	091	FK578 must exist if FK205 is missing.
Compensation with unknown value	599	OkandVarde	0-1	Kryss		
Received compensation	810	ErhallenErsattning	0-1	Belopp10	128, 169	FK810 must exist if Fk205 and FK599 and FK813 are missing. FK810 cannot exist if FK599 exists.
Type of option	812	TypAvOption	0-1	TypOption	130	FK812 must exist if FK205 is missing.
Maturity	813	OptionenForfallen	0-1	Kryss	131, 172	FK813 cannot exist if FK810 exists. FK813 cannot exist if FK599 exists.
Income earner		InkomsttagareKU34	1	Grp		
Information provider		UppgiftslamnareKU34	1	Grp		

SKV 260 appendix 2	Version: 5.0
XML-struktur	2019-02-21

6.2.16.1 Element: *InkomsttagareKU34*

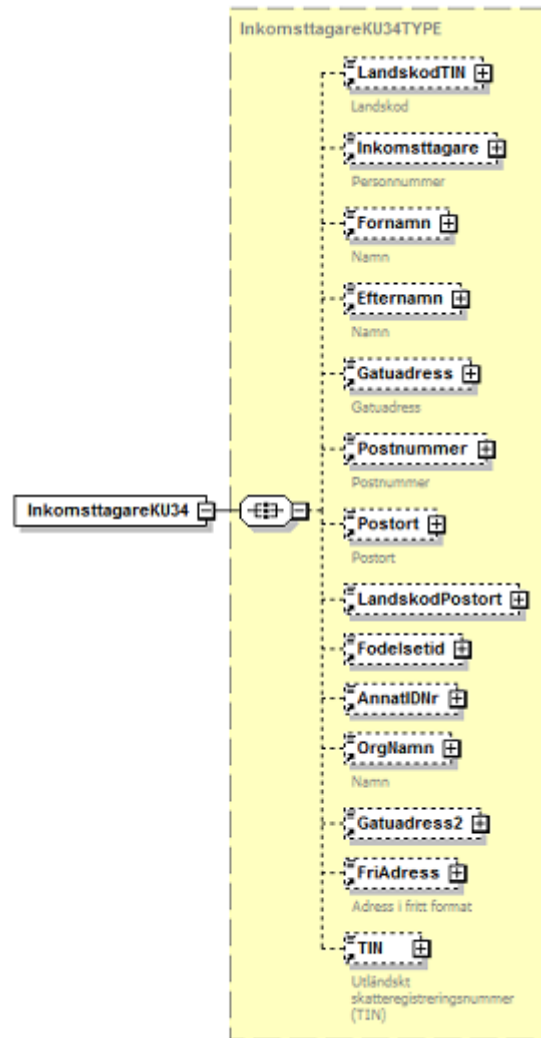

SKV 260 appendix 2	Version: 5.0
XML-struktur	2019-02-21

Term/Field Description	Code	Element name in XML	No.	Type	Controls	
					ID	Description
Country code for TIN	076	LandskodTIN	0-1	Landskod	045	FK076 must exist if FK252 exists.
Personal identity number	215	Inkomsttagare	0-1	Identitet	056	Fk215 must exist if Fk222 and Fk224 are missing.
Person's first name	216	Fornamn	0-1	Text50	057, 142	FK216 must exist if FK222 exists and FK 205 is missing FK216 must exist if FK215 has the value CCYY > 1800 and DD > 60 and Fk205 is missing
Person's last name	217	Efternamn	0-1	Text50	058, 143	FK217 must exist if FK222 exists and FK 205 is missing FK217 must exist if FK215 has the value CCYY > 1800 and DD > 60 and Fk205 is missing
Person's address	218	Gatuadress	0-1	Text50	059, 144, 152	FK218 must exist if FK222 exists and FK 205 and FK230 is missing FK218 must exist if CCYY > 1800 and DD > 60 in FK215 and Fk205 and FK230 is missing FK218 must exist if FK224 exists and FK205 and FK215 and FK222 and FK230 is missing
Person's address continuing	228	Gatuadress2	0-1	Text50		
Person's post number	219	Postnummer	0-1	PostNummer	060, 145, 153	FK219 must exist if FK222 exists and FK 205 and FK230 is missing FK219 must exist if CCYY > 1800 and DD > 60 in FK215 and Fk205 and FK230 is missing FK219 must exist if FK224 exists and FK205 and FK215 and FK222 and FK230 is missing
Person's postal location	220	Postort	0-1	Text50	061, 146, 154	FK220 must exist if FK222 exists and FK 205 and FK230 is missing FK220 must exist if CCYY > 1800 and DD > 60 in FK215 and Fk205 and FK230 is missing FK220 must exist if FK224 exists and FK205 and FK215 and FK222 and FK230 is missing
Country code for postal location	221	LandskodPostort	0-1	Landskod	166	FK221 must exist if FK230 exists
Date of birth	222	Fodelsetid	0-1	Fodelsetid	063	FK222 cannot exist if FK215 exists
Other ID number for a legal entity	224	AnnatIDNr	0-1	Text20		

SKV 260 appendix 2	Version: 5.0
XML-struktur	2019-02-21

Term/Field Description	Code	Element name in XML	No.	Type	Controls	
					ID	Description
Name of legal entity	226	OrgNamn	0-1	Text50	065, 151	FK226 can not exist if Fk222 exists, if CC > 17 in FK215, if Fk216 exists or if Fk217 exists. FK226 must exist if FK224 exists and FK205 and FK215, FK216, FK217 and FK222 is missing
Address in free format	230	FriAdress	0-1	Text350		
Foreign tax identification number (TIN). Other than Swedish	252	TIN	0-1	Text20	066	FK252 must exist if FK076 exists

6.2.16.2 Element: UppgiftslamnareKU34

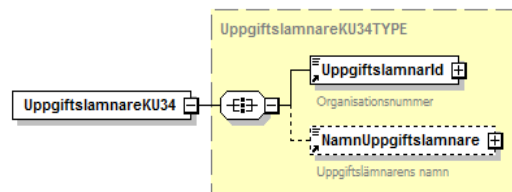

Term/Field Description	Code	Element name in XML	No.	Type	Controls	
					ID	Description
Information provider's organization number	201	UppgiftslamnarId	1	Identitet	053	FK201 can not be equal to FK215
Information provider's name	202	NamnUppgiftslamnare	0-1	Text50		

6.2.16.3 Changes compared to income year 2018 in KU34

Term/Field Description	Code	Element name in XML	No.	Type	Controls		Changes
					ID	Description	
No changes							

SKV 260 appendix 2	Version: 5.0
XML-struktur	2019-02-21

6.2.17 KU35 – Income statement for completion of futures

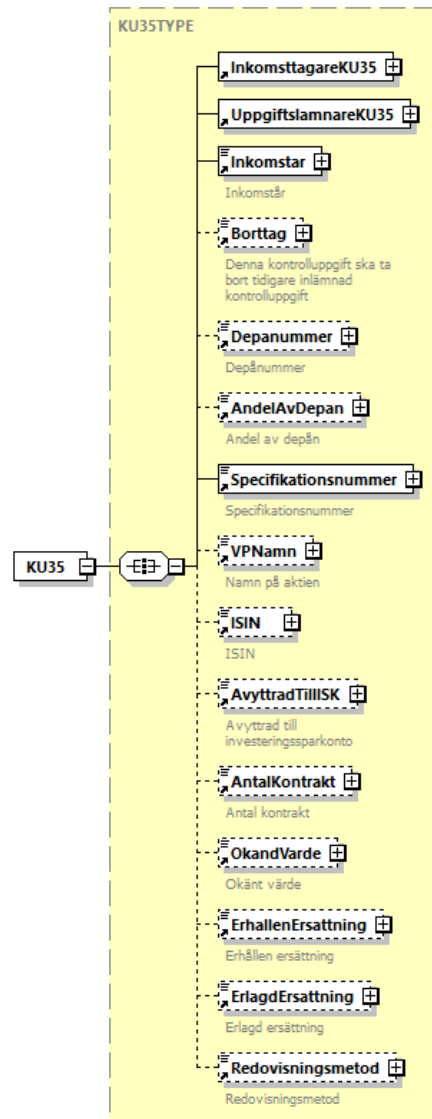

SKV 260 appendix 2	Version: 5.0
XML-struktur	2019-02-21

Term/Field Description	Code	Element name in XML	No.	Type	Controls	
					ID	Description
Income year	203	Inkomstar	1	Inkomstar		
Removal	205	Borttag	0-1	Kryss	055	FK205 can only exist if all codes but Fk201, Fk203, Fk570, Fk215, Fk222 and Fk224 are missing.
Deposit number	523	Depanummer	0-1	Belopp12		
Share of the deposit	524	AndelAvDepan	0-1	Decimal2	076	If Fk524 exists, Fk 523 must also exist
Specification number	570	Specifikationsnummer	1	SpecifikationsNummer		
The fund's title	571	VPNamn	0-1	Text50	085, 170	"FK571 must exist if FK572 and FK205 is missing FK571 must exist if (FK572 exist and the two first characters in FK572 are not SE)"
ISIN	572	ISIN	0-1	Isin		
Transferred to investment savings account	573	AvyttradTillISK	0-1	Kryss		
Number of contracts	578	AntalKontrakt	0-1	Belopp10	091	FK578 must exist if FK205 is missing.
Compensation with unknown value	599	OkandVarde	0-1	Kryss		
Received compensation	810	ErhallenErsattning	0-1	Belopp10	129, 169	Fk810 must exist if FK205 and Fk811 is missing FK810 cannot exist if FK599 exists.
Paid compensation	811	ErlagdErsattning	0-1	Belopp10		
Gross/Net	814	Redovisningsmetod	0-1	Redovisningsmetod	132	Fk814 must exist if FK205 is missing.
Income earner		InkomsttagareKU35	1	Grp		
Information provider		UppgiftslamnareKU35	1	Grp		

SKV 260 appendix 2	Version: 5.0
XML-struktur	2019-02-21

6.2.17.1 Element: *InkomsttagareKU35*

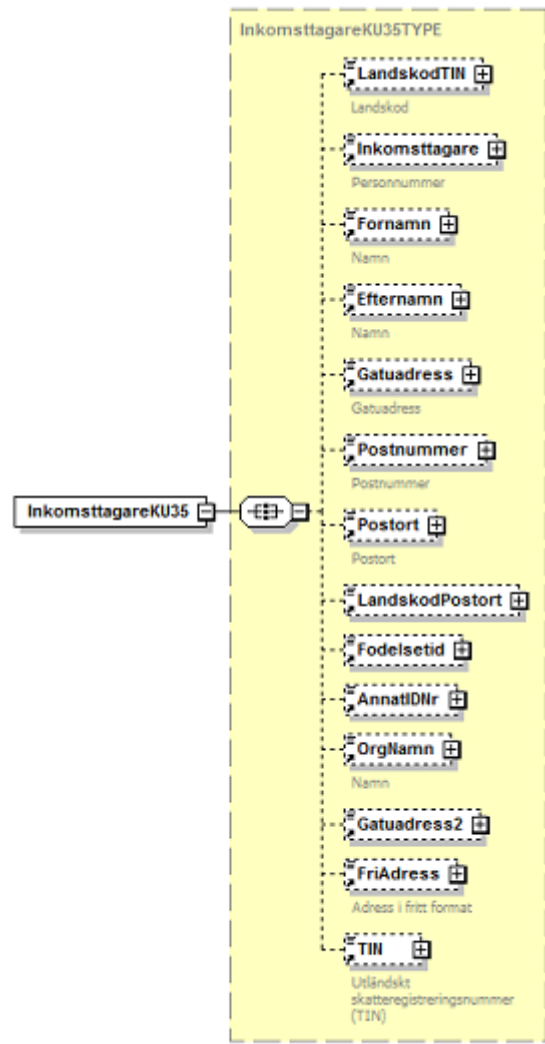

SKV 260 appendix 2	Version: 5.0
XML-struktur	2019-02-21

Term/Field Description	Code	Element name in XML	No.	Type	Controls	
					ID	Description
Country code for TIN	076	LandskodTIN	0-1	Landskod	045	FK076 must exist if FK252 exists.
Personal identity number	215	Inkomsttagare	0-1	Identitet	056	Fk215 must exist if Fk222 and Fk224 are missing.
Person's first name	216	Fornamn	0-1	Text50	057, 142	FK216 must exist if FK222 exists and FK 205 is missing FK216 must exist if FK215 has the value CCYY > 1800 and DD > 60 and Fk205 is missing
Person's last name	217	Efternamn	0-1	Text50	058, 143	FK217 must exist if FK222 exists and FK 205 is missing FK217 must exist if FK215 has the value CCYY > 1800 and DD > 60 and Fk205 is missing
Person's address	218	Gatuadress	0-1	Text50	059, 144, 152	FK218 must exist if FK222 exists and FK 205 and FK230 is missing FK218 must exist if CCYY > 1800 and DD > 60 in FK215 and Fk205 and FK230 is missing FK218 must exist if FK224 exists and FK205 and FK215 and FK222 and FK230 is missing
Person's address continuing	228	Gatuadress2	0-1	Text50		
Person's post number	219	Postnummer	0-1	PostNummer	060, 145, 153	FK219 must exist if FK222 exists and FK 205 and FK230 is missing FK219 must exist if CCYY > 1800 and DD > 60 in FK215 and Fk205 and FK230 is missing FK219 must exist if FK224 exists and FK205 and FK215 and FK222 and FK230 is missing
Person's postal location	220	Postort	0-1	Text50	061, 146, 154	FK220 must exist if FK222 exists and FK 205 and FK230 is missing FK220 must exist if CCYY > 1800 and DD > 60 in FK215 and Fk205 and FK230 is missing FK220 must exist if FK224 exists and FK205 and FK215 and FK222 and FK230 is missing
Country code for postal location	221	LandskodPostort	0-1	Landskod	166	FK221 must exist if FK230 exists
Date of birth	222	Fodelsetid	0-1	Fodelsetid	063	FK222 can not exist if FK215 exists
Other ID number for a legal entity	224	AnnatIDNr	0-1	Text20		

SKV 260 appendix 2	Version: 5.0
XML-struktur	2019-02-21

Term/Field Description	Code	Element name in XML	No.	Type	Controls	
					ID	Description
Name of legal entity	226	OrgNamn	0-1	Text50	065, 151	FK226 can not exist if Fk222 exists, if CC > 17 in FK215, if Fk216 exists or if Fk217 exists. FK226 must exist if FK224 exists and FK205 and FK215, FK216, FK217 and FK222 is missing
Address in free format	230	FriAdress	0-1	Text350		
Foreign tax identification number (TIN). Other than Swedish	252	TIN	0-1	Text20	066	FK252 must exist if FK076 exists

6.2.17.2 Element: UppgiftslamnareKU35

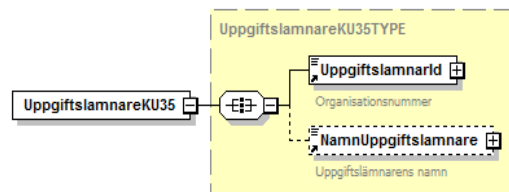

Term/Field Description	Code	Element name in XML	No.	Type	Controls	
					ID	Description
Information provider's organization number	201	UppgiftslamnarId	1	Identitet	053	FK201 can not be equal to FK215
Information provider's name	202	NamnUppgiftslamnare	0-1	Text50		

6.2.17.3 Changes compared to income year 2018 in KU35

Term/Field Description	Code	Element name in XML	No.	Type	Controls		Changes
					ID	Description	
No changes							

SKV 260 appendix 2	Version: 5.0
XML-struktur	2019-02-21

6.2.18 KU40 – Income statement for transfer of shares in investment funds

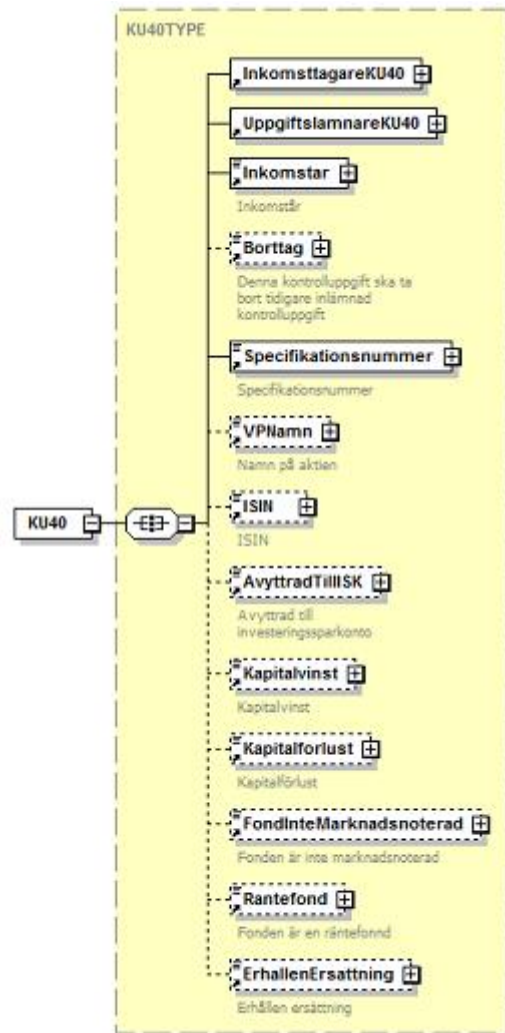

SKV 260 appendix 2	Version: 5.0
XML-struktur	2019-02-21

Term/Field Description	Code	Element name in XML	No.	Type	Controls	
					ID	Description
Income year	203	Inkomstar	1	Inkomstar		
Removal	205	Borttag	0-1	Kryss	055	FK205 can only exist if all codes but Fk201, Fk203, Fk570, Fk215, Fk222 and Fk224 are missing.
Specification number	570	Specifikationsnummer	1	SpecifikationsN ummer		
The fund's title	571	VPNamn	0-1	Text50	085, 170	"FK571 must exist if FK572 and FK205 is missing FK571 must exist if (FK572 exist and the two first characters in FK572 are not SE)"
ISIN	572	ISIN	0-1	Isin		
Transferred to investment savings account	573	AvytradTillISK	0-1	Kryss		
Capital gain	600	Kapitalvinst	0-1	Belopp10	093	FK600 must exist when FK205, FK601 and FK810 is missing.
Capital loss	601	Kapitalforlust	0-1	Belopp10		
The fund has not been listed on the market	602	FondInteMarknadsnoterad	0-1	Kryss		
Bond fund	606	Rantefond	0-1	Kryss		
Received compensation	810	ErhallenErsattning	0-1	Belopp10	094	FK810 cannot exist if FK600 and/or FK601 exist.
Income earner		InkomsttagareKU40	1	Grp		
Information provider		UppgiftslamnareKU40	1	Grp		

SKV 260 appendix 2	Version: 5.0
XML-struktur	2019-02-21

6.2.18.1 Element: *InkomsttagareKU40*

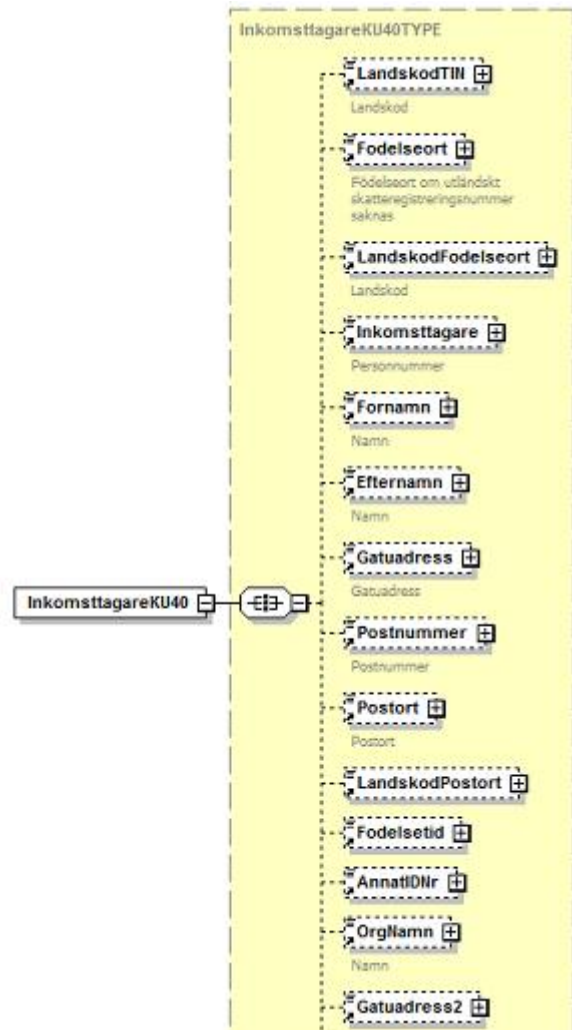

SKV 260 appendix 2	Version: 5.0
XML-struktur	2019-02-21



Term/Field		Element name in XML	No.	Type	Controls	
Description	Code				ID	Description
Country code for TIN	076	LandskodTIN	0-1	Landskod	045	FK076 must exist if FK252 exists.
Birthplace	077	Fodelseort	0-1	Text35		
Country code for birthplace	078	LandskodFodelseort	0-1	Landskod	046	FK078 must exist if Fk077 exists.
Personal identity number	215	Inkomsttagare	0-1	Identitet	056	Fk215 must exist if Fk222 and Fk224 are missing.
Person's first name	216	Fornamn	0-1	Text50	057, 142	FK216 must exist if FK222 exists and FK 205 is missing FK216 must exist if FK215 has the value CCYY > 1800 and DD > 60 and Fk205 is missing
Person's last name	217	Efternamn	0-1	Text50	058, 143	FK217 must exist if FK222 exists and FK 205 is missing FK217 must exist if FK215 has the value CCYY > 1800 and DD > 60 and Fk205 is missing
Person's address	218	Gatuadress	0-1	Text50	059, 144, 152	FK218 must exist if FK222 exists and FK 205 and FK230 is missing FK218 must exist if CCYY > 1800 and DD > 60 in FK215 and Fk205 and FK230 is missing FK218 must exist if FK224 exists and FK205 and FK215 and FK222 and FK230 is missing
Person's address continuing	228	Gatuadress2	0-1	Text50		
Person's post number	219	Postnummer	0-1	PostNummer	060, 145, 153	FK219 must exist if FK222 exists and FK 205 and FK230 is missing FK219 must exist if CCYY > 1800 and DD > 60 in FK215 and Fk205 and FK230 is missing FK219 must exist if FK224 exists and FK205 and FK215 and FK222 and FK230 is missing

SKV 260 appendix 2	Version: 5.0
XML-struktur	2019-02-21

Term/Field Description	Code	Element name in XML	No.	Type	Controls	
					ID	Description
Person's postal location	220	Postort	0-1	Text50	061, 146, 154	FK220 must exist if FK222 exists and FK 205 and FK230 is missing FK220 must exist if CCYY > 1800 and DD > 60 in FK215 and Fk205 and FK230 is missing FK220 must exist if FK224 exists and FK205 and FK215 and FK222 and FK230 is missing
Country code for postal location	221	LandskodPostort	0-1	Landskod	166	FK221 must exist if FK230 exists
Date of birth	222	Fodelsetid	0-1	Fodelsetid	063	FK222 can not exist if FK215 exists
Other ID number for a legal entity	224	AnnatIDNr	0-1	Text20		
Name of legal entity	226	OrgNamn	0-1	Text50	065, 151	FK226 can not exist if Fk222 exists, if CC > 17 in FK215, if Fk216 exists or if Fk217 exists. FK226 must exist if FK224 exists and FK205 and FK215, FK216, FK217 and FK222 is missing
Address in free format	230	FriAdress	0-1	Text350		
Foreign tax identification number (TIN). Other than Swedish	252	TIN	0-1	Text20	066	FK252 must exist if FK076 exists

6.2.18.2 Element: UppgiftslamnareKU40

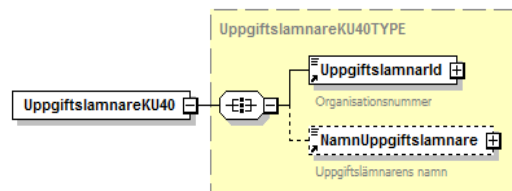

Term/Field Description	Code	Element name in XML	No.	Type	Controls	
					ID	Description
Information provider's organization number	201	UppgiftslamnarId	1	Identitet	053	FK201 can not be equal to FK215
Information provider's name	202	NamnUppgiftslamnare	0-1	Text50		

SKV 260 appendix 2	Version: 5.0
XML-struktur	2019-02-21

6.2.18.3 Changes compared to income year 2018 in KU40

Term/Field Description	Code	Element name in XML	No.	Type	Controls		Changes
					ID	Description	
No changes							

6.2.19 KU41 – Income statement – Investment fund – standard income

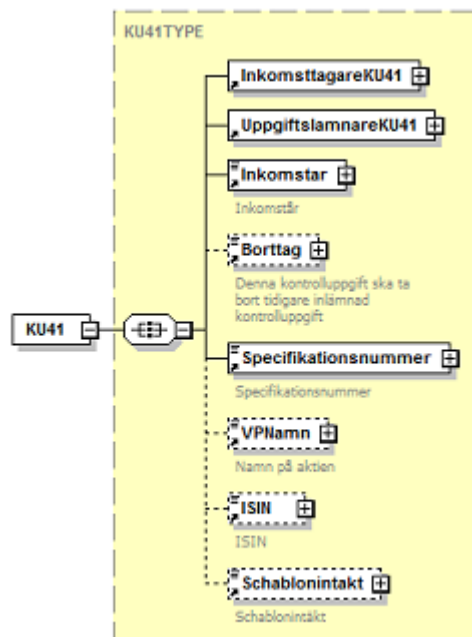

Term/Field Description	Code	Element name in XML	No.	Type	Controls	
					ID	Description
Income year	203	Inkomstar	1	Inkomstar		

SKV 260 appendix 2	Version: 5.0
XML-struktur	2019-02-21

Term/Field Description	Code	Element name in XML	No.	Type	Controls	
					ID	Description
Removal	205	Borttag	0-1	Kryss	055	FK205 can only exist if all codes but Fk201, Fk203, Fk570, Fk215, Fk222 and Fk224 are missing.
Specification number	570	Specifikationsnummer	1	SpecifikationsNummer		
The fund's title	571	VPNamn	0-1	Text50	085, 170	"FK571 must exist if FK572 and FK205 is missing FK571 must exist if (FK572 exist and the two first characters in FK572 are not SE)"
ISIN	572	ISIN	0-1	Isin		
Standard income	815	Schablonintakt	0-1	Belopp10	133	Fk815 must exist if FK205 is missing.
Income earner		InkomsttagareKU41	1	Grp		
Information provider		UppgiftslamnareKU41	1	Grp		

SKV 260 appendix 2	Version: 5.0
XML-struktur	2019-02-21

6.2.19.1 Element: *InkomsttagareKU41*

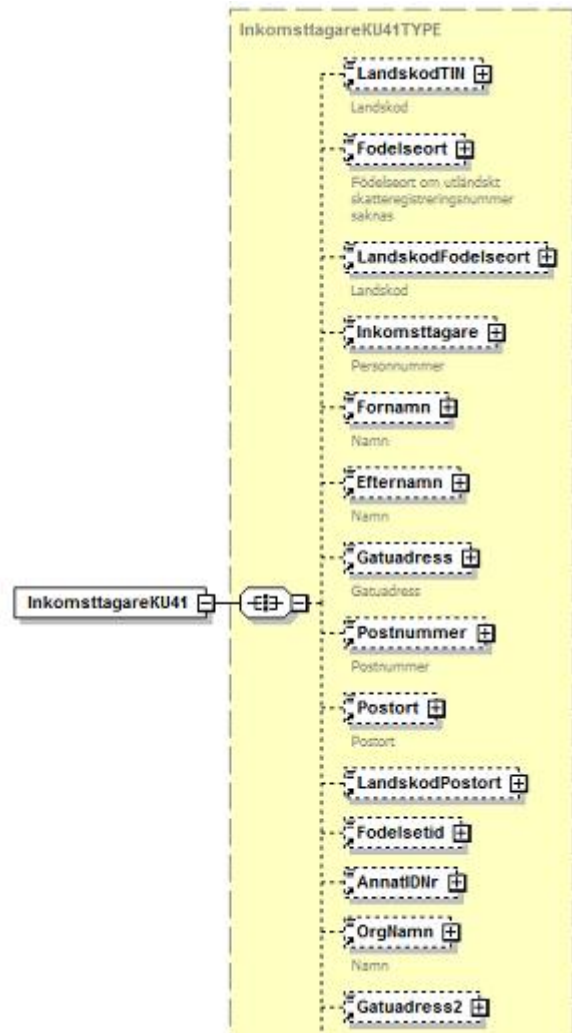

SKV 260 appendix 2	Version: 5.0
XML-struktur	2019-02-21



Term/Field		Element name in XML	No.	Type	Controls	
Description	Code				ID	Description
Country code for TIN	076	LandskodTIN	0-1	Landskod	045	FK076 must exist if FK252 exists.
Birthplace	077	Fodelseort	0-1	Text35		
Country code for birthplace	078	LandskodFodelseort	0-1	Landskod	046	FK078 must exist if Fk077 exists.
Personal identity number	215	Inkomsttagare	0-1	Identitet	056	Fk215 must exist if Fk222 and Fk224 are missing.
Person's first name	216	Fornamn	0-1	Text50	057, 142	FK216 must exist if FK222 exists and FK 205 is missing FK216 must exist if FK215 has the value CCYY > 1800 and DD > 60 and Fk205 is missing
Person's last name	217	Efternamn	0-1	Text50	058, 143	FK217 must exist if FK222 exists and FK 205 is missing FK217 must exist if FK215 has the value CCYY > 1800 and DD > 60 and Fk205 is missing
Person's address	218	Gatuadress	0-1	Text50	059, 144, 152	FK218 must exist if FK222 exists and FK 205 and FK230 is missing FK218 must exist if CCYY > 1800 and DD > 60 in FK215 and Fk205 and FK230 is missing FK218 must exist if FK224 exists and FK205 and FK215 and FK222 and FK230 is missing
Person's address continuing	228	Gatuadress2	0-1	Text50		
Person's post number	219	Postnummer	0-1	PostNummer	060, 145, 153	FK219 must exist if FK222 exists and FK 205 and FK230 is missing FK219 must exist if CCYY > 1800 and DD > 60 in FK215 and Fk205 and FK230 is missing FK219 must exist if FK224 exists and FK205 and FK215 and FK222 and FK230 is missing

SKV 260 appendix 2	Version: 5.0
XML-struktur	2019-02-21

Term/Field Description	Code	Element name in XML	No.	Type	Controls	
					ID	Description
Person's postal location	220	Postort	0-1	Text50	061, 146, 154	FK220 must exist if FK222 exists and FK 205 and FK230 is missing FK220 must exist if CCYY > 1800 and DD > 60 in FK215 and Fk205 and FK230 is missing FK220 must exist if FK224 exists and FK205 and FK215 and FK222 and FK230 is missing
Country code for postal location	221	LandskodPostort	0-1	Landskod	166	FK221 must exist if FK230 exists
Date of birth	222	Fodelsetid	0-1	Fodelsetid	063	FK222 can not exist if FK215 exists
Other ID number for a legal entity	224	AnnatIDNr	0-1	Text20		
Name of legal entity	226	OrgNamn	0-1	Text50	065, 151	FK226 can not exist if Fk222 exists, if CC > 17 in FK215, if Fk216 exists or if Fk217 exists. FK226 must exist if FK224 exists and FK205 and FK215, FK216, FK217 and FK222 is missing
Address in free format	230	FriAdress	0-1	Text350		
Foreign tax identification number (TIN). Other than Swedish	252	TIN	0-1	Text20	066	FK252 must exist if FK076 exists

6.2.19.2 Element: UppgiftslamnareKU41

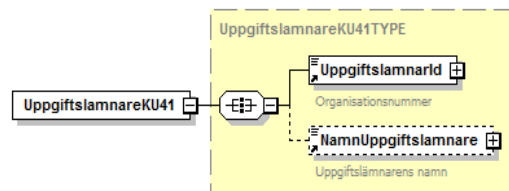

Term/Field Description	Code	Element name in XML	No.	Type	Controls	
					ID	Description
Information provider's organization number	201	UppgiftslamnarId	1	Identitet	053	FK201 can not be equal to FK215
Information provider's name	202	NamnUppgiftslamnare	0-1	Text50		

SKV 260 appendix 2	Version: 5.0
XML-struktur	2019-02-21

6.2.19.3 Changes compared to income year 2018 in KU41

Term/Field Description	Code	Element name in XML	No.	Type	Controls		Changes
					ID	Description	
No changes							

SKV 260 appendix 2	Version: 5.0
XML-struktur	2019-02-21

6.2.20 KU50 – Income statement for pension savings

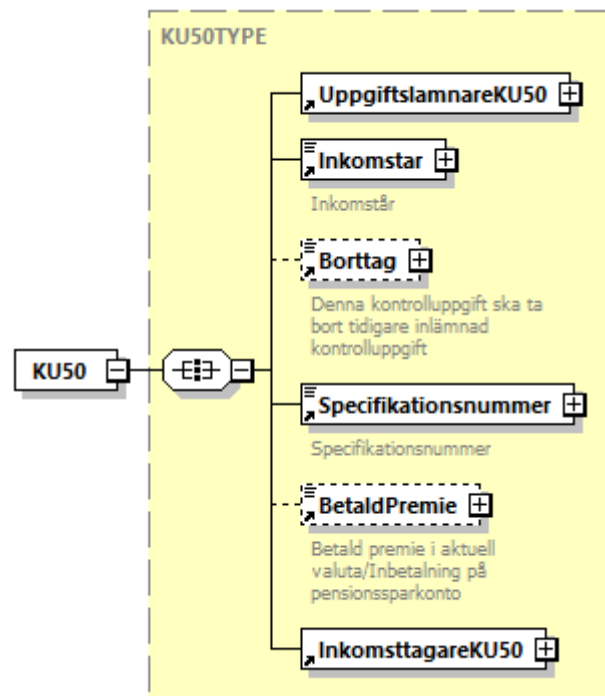

Term/Field					Controls	
Description	Code	Element name in XML	No.	Type	ID	Description
Income year	203	Inkomstar	1	Inkomstar		
Removal	205	Borttag	0-1	Kryss	055	FK205 can only exist if all codes but Fk201, Fk203, Fk570, Fk215, Fk222 and Fk224 are missing.
Specification number	570	Specifikationsnummer	1	SpecifikationsNummer		
Paid premium in applicable currency	620	BetaldPremie	0-1	Belopp10	095	Fk620 must exist if FK205 is missing
Income earner		InkomsttagareKU50	1	Grp		

SKV 260 appendix 2	Version: 5.0
XML-struktur	2019-02-21

Term/Field		Element name in XML	No.	Type	Controls	
Description	Code				ID	Description
Information provider		UppgiftslamnareKU50	1	Grp		

SKV 260 appendix 2	Version: 5.0
XML-struktur	2019-02-21

6.2.20.1 Element: *InkomsttagareKU50*

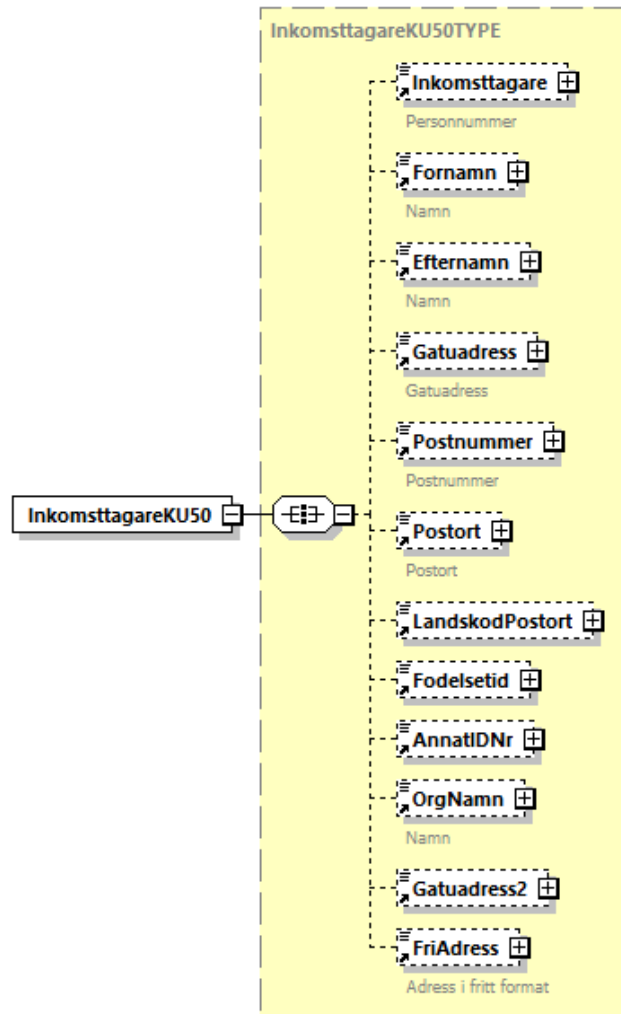

SKV 260 appendix 2	Version: 5.0
XML-struktur	2019-02-21

Term/Field Description	Code	Element name in XML	No.	Type	Controls	
					ID	Description
Personal identity number	215	Inkomsttagare	0-1	Identitet	056	Fk215 must exist if Fk222 and Fk224 are missing.
Person's first name	216	Fornamn	0-1	Text50	057, 142	FK216 must exist if FK222 exists and FK 205 is missing FK216 must exist if FK215 has the value CCYY > 1800 and DD > 60 and Fk205 is missing
Person's last name	217	Efternamn	0-1	Text50	058, 143	FK217 must exist if FK222 exists and FK 205 is missing FK217 must exist if FK215 has the value CCYY > 1800 and DD > 60 and Fk205 is missing
Person's address	218	Gatuadress	0-1	Text50	059, 144, 152	FK218 must exist if FK222 exists and FK 205 and FK230 is missing FK218 must exist if CCYY > 1800 and DD > 60 in FK215 and Fk205 and FK230 is missing FK218 must exist if FK224 exists and FK205 and FK215 and FK222 and FK230 is missing
Person's address continuing	228	Gatuadress2	0-1	Text50		
Person's post number	219	Postnummer	0-1	PostNummer	060, 145, 153	FK219 must exist if FK222 exists and FK 205 and FK230 is missing FK219 must exist if CCYY > 1800 and DD > 60 in FK215 and Fk205 and FK230 is missing FK219 must exist if FK224 exists and FK205 and FK215 and FK222 and FK230 is missing
Person's postal location	220	Postort	0-1	Text50	061, 146, 154	FK220 must exist if FK222 exists and FK 205 and FK230 is missing FK220 must exist if CCYY > 1800 and DD > 60 in FK215 and Fk205 and FK230 is missing FK220 must exist if FK224 exists and FK205 and FK215 and FK222 and FK230 is missing
Country code for postal location	221	LandskodPostort	0-1	Landskod	166	FK221 must exist if FK230 exists
Date of birth	222	Fodelsetid	0-1	Fodelsetid	063	FK222 can not exist if FK215 exists
Other ID number for a legal entity	224	AnnatIDNr	0-1	Text20		

SKV 260 appendix 2	Version: 5.0
XML-struktur	2019-02-21

Term/Field Description	Code	Element name in XML	No.	Type	Controls	
					ID	Description
Name of legal entity	226	OrgNamn	0-1	Text50	065, 151	FK226 can not exist if Fk222 exists, if CC > 17 in FK215, if Fk216 exists or if Fk217 exists. FK226 must exist if FK224 exists and FK205 and FK215, FK216, FK217 and FK222 is missing
Address in free format	230	FriAdress	0-1	Text350		
Foreign tax identification number (TIN). Other than Swedish	252	TIN	0-1	Text20	066	FK252 must exist if FK076 exists

6.2.20.2 Element: UppgiftslamnareKU50

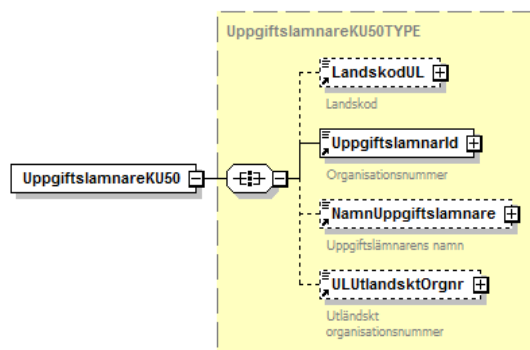

Term/Field Description	Code	Element name in XML	No.	Type	Controls	
					ID	Description
Country code for foreign organization number	075	LandskodUL	0-1	Landskod	043	Fk075 must exist if Fk506 exists
Information provider's organization number	201	UppgiftslamnarId	1	Identitet	053	FK201 can not be equal to FK215
Information provider's name	202	NamnUppgiftslamnare	0-1	Text50		
Information provider's foreign organization number	506	ULUtlandsktOrgnr	0-1	Text13	072	Fk506 must exist if Fk075 exists

SKV 260 appendix 2	Version: 5.0
XML-struktur	2019-02-21

6.2.20.3 Changes compared to income year 2018 in KU50

Term/Field		Element name in XML	No.	Type	Controls		Changes
Description	Code				ID	Description	
Country code for TIN	076	LandskodTIN	0-1	Landskod	045	FK076 must exist if FK252 exists.	Removed field
Foreign tax identification number (TIN). Other than Swedish	252	TIN	0-1	Text20	066	FK252 must exist if FK076 exists	Removed field
Insurance agreement number	507	Forsakringsavtalsnummer	0-1	Text30			Removed field

SKV 260 appendix 2	Version: 5.0
XML-struktur	2019-02-21

6.2.21 KU52 – Income statement for foreign insurance

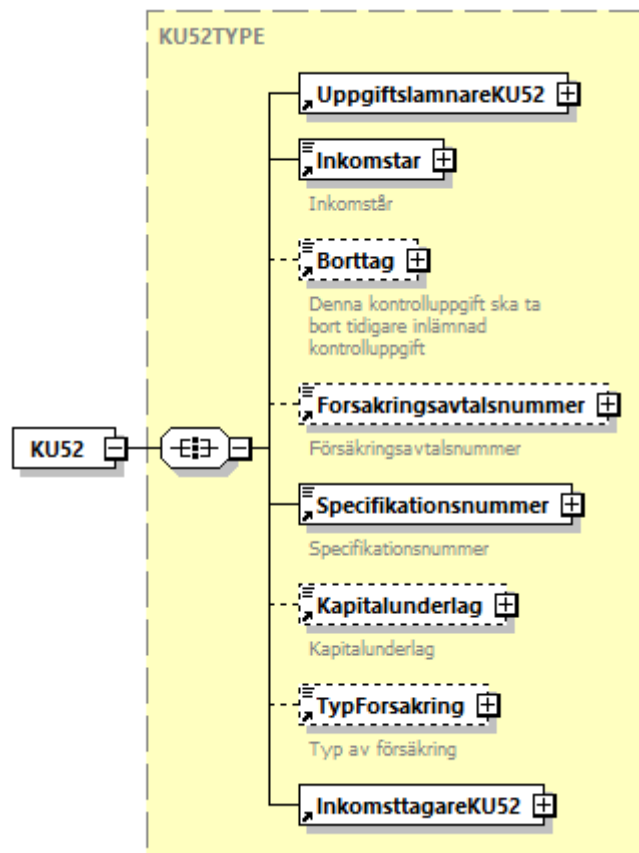

Term/Field					Controls	
Description	Code	Element name in XML	No.	Type	ID	Description
Income year	203	Inkomstar	1	Inkomstar		
Removal	205	Borttag	0-1	Kryss	055	FK205 can only exist if all codes but Fk201, Fk203, Fk570, Fk215, Fk222 and Fk224 are missing.
Insurance agreement number	507	Forsakringsavtalsnummer	0-1	Text30	074	Fk507 must exist if Fk654=P

SKV 260 appendix 2	Version: 5.0
XML-struktur	2019-02-21

Term/Field		Element name in XML	No.	Type	Controls	
Description	Code				ID	Description
Specification number	570	Specifikationsnummer	1	SpecifikationsNummer		
Value at end of previous year	652	Kapitalunderlag	0-1	Belopp12	107	Fk652 must exist if FK205 is missing
Type of insurance, see definitions	654	TypForsakring	0-1	TypForsakring	108	Fk654 must exist if FK205 is missing
Currency code	664	Valutakod	0-1	Valutakod		
Income earner		InkomsttagareKU52	1	Grp		
Information provider		UppgiftslamnareKU52	1	Grp		

SKV 260 appendix 2	Version: 5.0
XML-struktur	2019-02-21

6.2.21.1 Element: *InkomsttagareKU52*

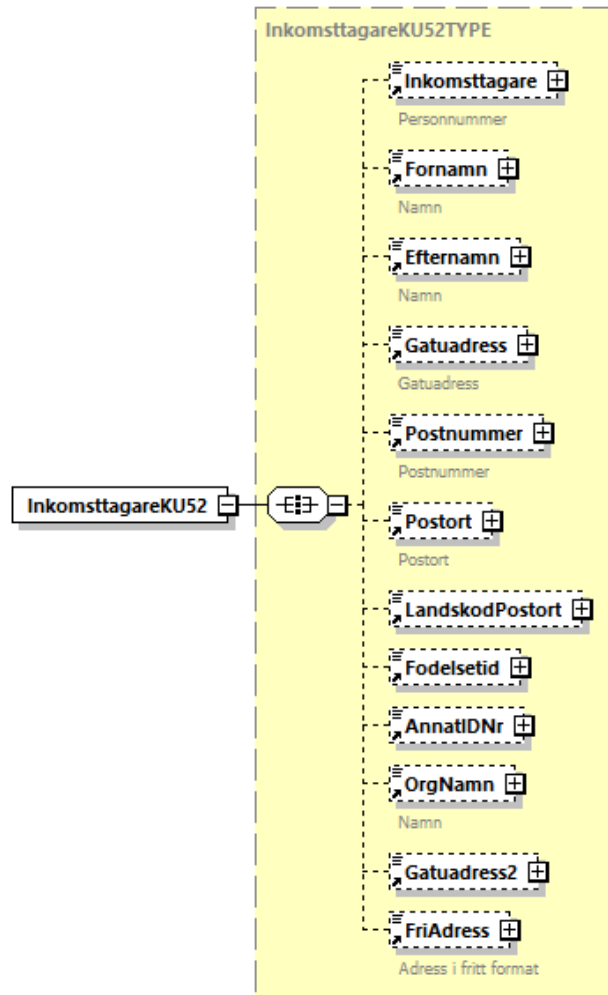

SKV 260 appendix 2	Version: 5.0
XML-struktur	2019-02-21

Term/Field Description	Code	Element name in XML	No.	Type	Controls	
					ID	Description
Personal identity number	215	Inkomsttagare	0-1	Identitet	056	Fk215 must exist if Fk222 and Fk224 are missing.
Person's first name	216	Fornamn	0-1	Text50	057, 142	FK216 must exist if FK222 exists and FK 205 is missing FK216 must exist if FK215 has the value CCYY > 1800 and DD > 60 and Fk205 is missing
Person's last name	217	Efternamn	0-1	Text50	058, 143	FK217 must exist if FK222 exists and FK 205 is missing FK217 must exist if FK215 has the value CCYY > 1800 and DD > 60 and Fk205 is missing
Person's address	218	Gatuadress	0-1	Text50	059, 144, 152	FK218 must exist if FK222 exists and FK 205 and FK230 is missing FK218 must exist if CCYY > 1800 and DD > 60 in FK215 and Fk205 and FK230 is missing FK218 must exist if FK224 exists and FK205 and FK215 and FK222 and FK230 is missing
Person's address continuing	228	Gatuadress2	0-1	Text50		
Person's post number	219	Postnummer	0-1	PostNummer	060, 145, 153	FK219 must exist if FK222 exists and FK 205 and FK230 is missing FK219 must exist if CCYY > 1800 and DD > 60 in FK215 and Fk205 and FK230 is missing FK219 must exist if FK224 exists and FK205 and FK215 and FK222 and FK230 is missing
Person's postal location	220	Postort	0-1	Text50	061, 146, 154	FK220 must exist if FK222 exists and FK 205 and FK230 is missing FK220 must exist if CCYY > 1800 and DD > 60 in FK215 and Fk205 and FK230 is missing FK220 must exist if FK224 exists and FK205 and FK215 and FK222 and FK230 is missing
Country code for postal location	221	LandskodPostort	0-1	Landskod	166	FK221 must exist if FK230 exists
Date of birth	222	Fodelsetid	0-1	Fodelsetid	063	FK222 can not exist if FK215 exists
Other ID number for a legal entity	224	AnnatIDNr	0-1	Text20		
Name of legal entity	226	OrgNamn	0-1	Text50	065, 151	FK226 can not exist if Fk222 exists, if CC > 17 in FK215, if Fk216 exists or if Fk217 exists. FK226 must exist if FK224 exists and FK205 and FK215, FK216, FK217 and FK222 is missing

SKV 260 appendix 2	Version: 5.0
XML-struktur	2019-02-21

Term/Field Description	Code	Element name in XML	No.	Type	Controls	
					ID	Description
Address in free format	230	FriAdress	0-1	Text350		

6.2.21.2 Element: UppgiftslamnareKU52

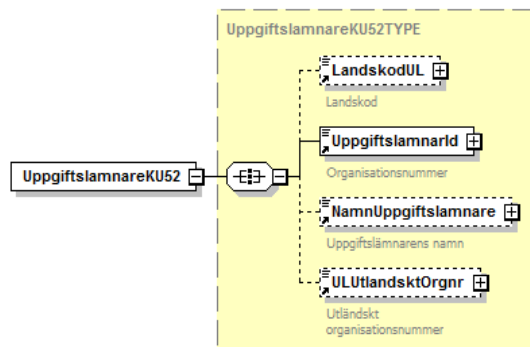

Term/Field Description	Code	Element name in XML	No.	Type	Controls	
					ID	Description
Country code for foreign organization number	075	LandskodUL	0-1	Landskod	044	If FK205 is missing Fk075 must exist
Information provider's organization number	201	UppgiftslamnarId	1	Identitet	053	FK201 can not be equal to FK215
Information provider's name	202	NamnUppgiftslamnare	0-1	Text50		
Information provider's foreign organization number	506	ULUtlandsktOrgnr	0-1	Text13	073	If FK205 is missing Fk506 must exist

SKV 260 appendix 2	Version: 5.0
XML-struktur	2019-02-21

6.2.21.3 Changes compared to income year 2018 in KU52

Term/Field		Element name in XML	No.	Type	Controls		Changes
Description	Code				ID	Description	
Country code for TIN	076	LandskodTIN	0-1	Landskod	045	FK076 must exist if FK252 exists.	Removed field
Foreign tax identification number (TIN). Other than Swedish	252	TIN	0-1	Text20	066	FK252 must exist if FK076 exists	Removed field

SKV 260 appendix 2	Version: 5.0
XML-struktur	2019-02-21

6.2.22 KU53 – Income statement regarding indirect insurance

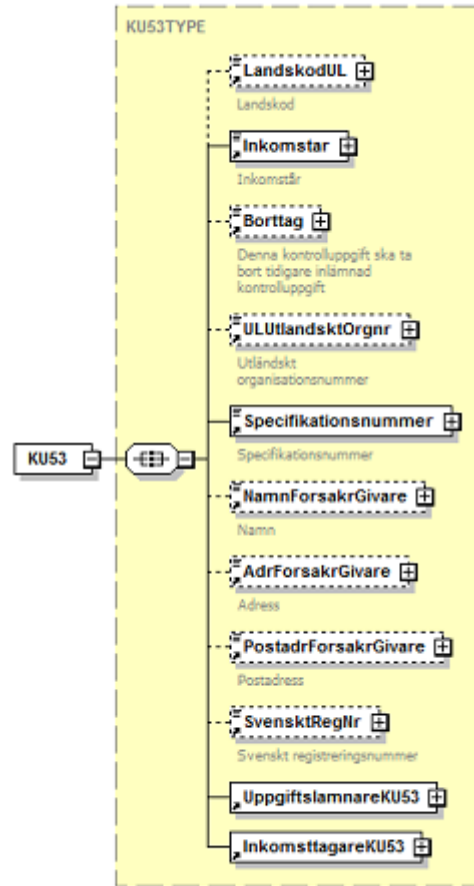

Term/Field					Controls	
Description	Code	Element name in XML	No.	Type	ID	Description
Country code for foreign organization number	075	LandskodUL	0-1	Landskod	044	Om FK205 saknas ska Fk075 finnas.
Income year	203	Inkomstar	1	Inkomstar		

SKV 260 appendix 2	Version: 5.0
XML-struktur	2019-02-21

Term/Field Description	Code	Element name in XML	No.	Type	Controls	
					ID	Description
Removal	205	Borttag	0-1	Kryss	055	FK205 can only exist if all codes but Fk201, Fk203, Fk570, Fk215, Fk222 and Fk224 are missing.
Information provider's foreign organization number	506	ULUtlandsktOrgnr	0-1	Text13	073	If FK205 is missing Fk506 must exist.
Specification number	570	Specifikationsnummer	1	SpecifikationsNummer		
Foreign insurer's name	680	NamnForsakrGivare	0-1	Text50	115	Fk680 must exist if Fk683 and FK205 is missing
Foreign insurer's address	681	AdrForsakrGivare	0-1	Text50	116	Fk681 must exist if Fk683 and FK205 is missing
Foreign insurer's postal location	682	PostadrForsakrGivare	0-1	Text50	117	Fk682 must exist if Fk683 and FK205 is missing
Foreign insurer's registration number	683	SvensktRegNr	0-1	Identitet		
Income earner		InkomsttagareKU53	1	Grp		
Information provider		UppgiftslamnareKU53	1	Grp		

SKV 260 appendix 2	Version: 5.0
XML-struktur	2019-02-21

6.2.22.1 Element: InkomstagareKU53

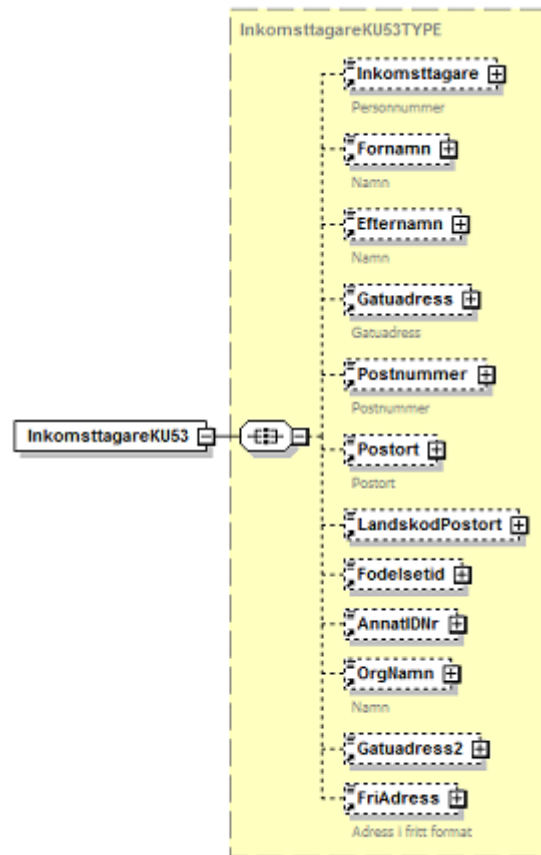

Term/Field		Element name in XML	No.	Type	Controls	
Description	Code				ID	Description
Personal identity number	215	Inkomstagare	0-1	Identitet	056	Fk215 must exist if Fk222 and Fk224 are missing.
Person's first name	216	Fornamn	0-1	Text50	057, 142	FK216 must exist if FK222 exists and FK 205 is missing FK216 must exist if FK215 has the value CCYY > 1800 and DD > 60 and Fk205 is missing

SKV 260 appendix 2	Version: 5.0
XML-struktur	2019-02-21

Term/Field		Element name in XML	No.	Type	Controls	
Description	Code				ID	Description
Person's last name	217	Efternamn	0-1	Text50	058, 143	FK217 must exist if FK222 exists and FK 205 is missing FK217 must exist if FK215 has the value CCYY > 1800 and DD > 60 and Fk205 is missing
Person's address	218	Gatuadress	0-1	Text50	059, 144, 152	FK218 must exist if FK222 exists and FK 205 and FK230 is missing FK218 must exist if CCYY > 1800 and DD > 60 in FK215 and Fk205 and FK230 is missing FK218 must exist if FK224 exists and FK205 and FK215 and FK222 and FK230 is missing
Person's address continuing	228	Gatuadress2	0-1	Text50		
Person's post number	219	Postnummer	0-1	PostNummer	060, 145, 153	FK219 must exist if FK222 exists and FK 205 and FK230 is missing FK219 must exist if CCYY > 1800 and DD > 60 in FK215 and Fk205 and FK230 is missing FK219 must exist if FK224 exists and FK205 and FK215 and FK222 and FK230 is missing
Person's postal location	220	Postort	0-1	Text50	061, 146, 154	FK220 must exist if FK222 exists and FK 205 and FK230 is missing FK220 must exist if CCYY > 1800 and DD > 60 in FK215 and Fk205 and FK230 is missing FK220 must exist if FK224 exists and FK205 and FK215 and FK222 and FK230 is missing
Country code for postal location	221	LandskodPostort	0-1	Landskod	166	FK221 must exist if FK230 exists
Date of birth	222	Fodelsetid	0-1	Fodelsetid	063	FK222 can not exist if FK215 exists
Other ID number for a legal entity	224	AnnatIDNr	0-1	Text20		
Name of legal entity	226	OrgNamn	0-1	Text50	065, 151	FK226 can not exist if Fk222 exists, if CC > 17 in FK215, if Fk216 exists or if Fk217 exists. FK226 must exist if FK224 exists and FK205 and FK215, FK216, FK217 and FK222 is missing
Address in free format	230	FriAdress	0-1	Text350		

SKV 260 appendix 2	Version: 5.0
XML-struktur	2019-02-21

6.2.22.2 Element: UppgiftslamnareKU53

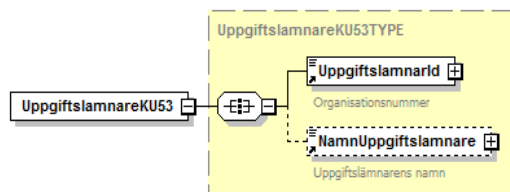

Term/Field					Controls	
Description	Code	Element name in XML	No.	Type	ID	Description
Information provider's organization number	201	UppgiftslamnarId	1	Identitet	053	FK201 can not be equal to FK215
Information provider's name	202	NamnUppgiftslamnare	0-1	Text50		

6.2.22.3 Changes compared to income year 2018 in KU53

Term/Field					Controls		
Description	Code	Element name in XML	No.	Type	ID	Description	Changes
No changes							

SKV 260 appendix 2	Version: 5.0
XML-struktur	2019-02-21

6.2.23 KU55 – Income statement regarding transfer of tenant-ownership in a housing association



SKV 260 appendix 2	Version: 5.0
XML-struktur	2019-02-21



Term/Field Description	Code	Element name in XML	No.	Type	Controls	
					ID	Description
Income year	203	Inkomstar	1	Inkomstar		
Removal	205	Borttag	0-1	Kryss	055	FK205 can only exist if all codes but Fk201, Fk203, Fk570, Fk215, Fk222 and Fk224 are missing.
Specification number	570	Specifikationsnummer	1	SpecifikationsNummer		
The cooperative property/flat's identification	630	BostRattBeteckning	0-1	Text36	097	Fk630 must exist if FK205 is missing

SKV 260 appendix 2	Version: 5.0
XML-struktur	2019-02-21

Term/Field Description	Code	Element name in XML	No.	Type	Controls	
					ID	Description
Date of transfer	631	Overlatelsesdatum	0-1	Datum	098, 099	Fk631 must exist if FK205 is missing. Fk631 can not be date later than the income year FK203.
Transferred part	632	OverlatenAndel	0-1	Decimal2-100		
Type of transfer	633	OverlatelseArvBodeln	0-1	Kryss	100	Fk633 can not exist if Fk634 or Fk639 exists.
Transfer price	634	Overlatelsepris	0-1	Belopp10	101	FK634 must exist if Fk205, Fk633 and Fk639 are missing.
Transferred reparation funds	635	InreRepFondOverlatelse	0-1	Belopp7		
Added capital	636	Kapitaltillskott	0-1	Belopp7		
The housing association is a housing association covered by the Companies Act (not a private housing association)	638	OaktaBostadsftg	0-1	Kryss		
Additional purchase sum	639	Tillaggskopeskilling	0-1	Belopp7		
Date of acquisition	640	Forvarvsdatum	0-1	Datum	102, 103	Fk640 must exist if FK205 is missing Fk640 can not be a date later than FK631.
Type of acquisition	642	ForvarvArvBodeln	0-1	Kryss		
Purchase price	643	Forvarvspris	0-1	Belopp10	104	Fk643 must exist if (Fk205, Fk633, Fk639, Fk642 and Fk645 are missing and Fk640 > 19831231)
Acquired reparation funds	644	InreRepFondForvarv	0-1	Belopp7		
Share 1974	645	AndelBRFFormogenhet1974	0-1	Belopp10		
Individual or common information	646	GemensamIndividuell	0-1	GemensamIndividuell	106	Fk646 must exist if FK205 is missing
Income earner		InkomsttagareKU55	1	Grp		
Information provider		UppgiftslamnareKU55	1	Grp		

SKV 260 appendix 2	Version: 5.0
XML-struktur	2019-02-21

6.2.23.1 Element: *InkomsttagareKU55*

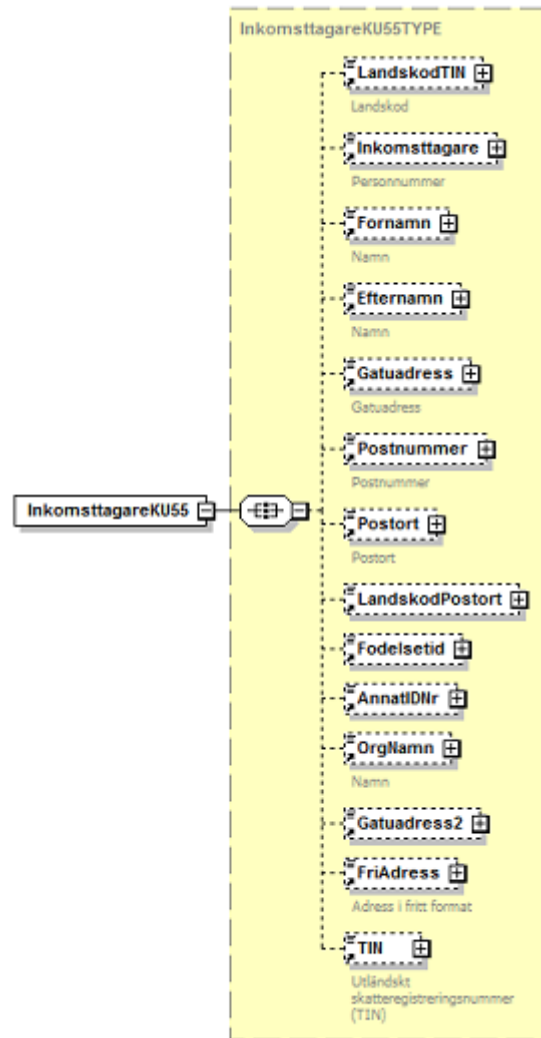

SKV 260 appendix 2	Version: 5.0
XML-struktur	2019-02-21

Term/Field Description	Code	Element name in XML	No.	Type	Controls	
					ID	Description
Country code for TIN	076	LandskodTIN	0-1	Landskod	045	FK076 must exist if FK252 exists.

6.2.23.2 Element: UppgiftslamnareKU55

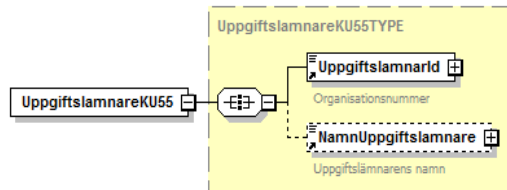

Term/Field Description	Code	Element name in XML	No.	Type	Controls	
					ID	Description
Information provider's organization number	201	UppgiftslamnarId	1	Identitet	053	FK201 can not be equal to FK215
Information provider's name	202	NamnUppgiftslamnare	0-1	Text50		

6.2.23.3 Changes compared to income year 2018 in KU55

Term/Field Description	Code	Element name in XML	No.	Type	Controls		Changes
					ID	Description	
No changes							

SKV 260 appendix 2	Version: 5.0
XML-struktur	2019-02-21

6.2.24 KU65 – Income statement donation

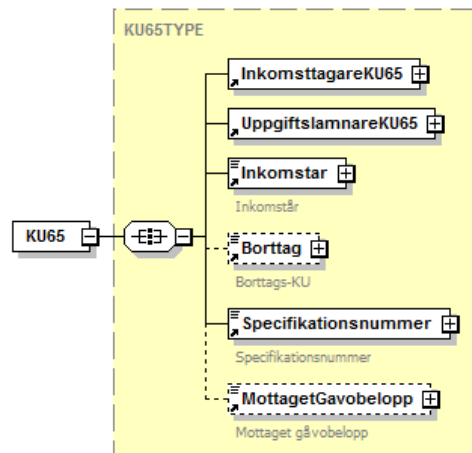

Term/Field Description	Code	Element name in XML	No.	Type	Controls	
					ID	Description
Period (year)	203	Inkomstar	1	Inkomstar		
Removal	205	Borttag	0-1	Kryss	055	FK205 can only exist if all codes but Fk201, Fk203, Fk570, Fk215, Fk222 and Fk224 are missing.
Specification number	570	Specifikationsnummer	1	SpecifikationsN ummer		
Received donation amount	621	MottagetGavobelopp	0-1	Belopp10	096	Fk621 must exist if FK205 is missing.
Income earner		InkomsttagareKU65	1	Grp		
information provider		UppgiftslamnareKU65	1	Grp		

SKV 260 appendix 2	Version: 5.0
XML-struktur	2019-02-21

6.2.24.1 Element: *InkomsttagareKU65*

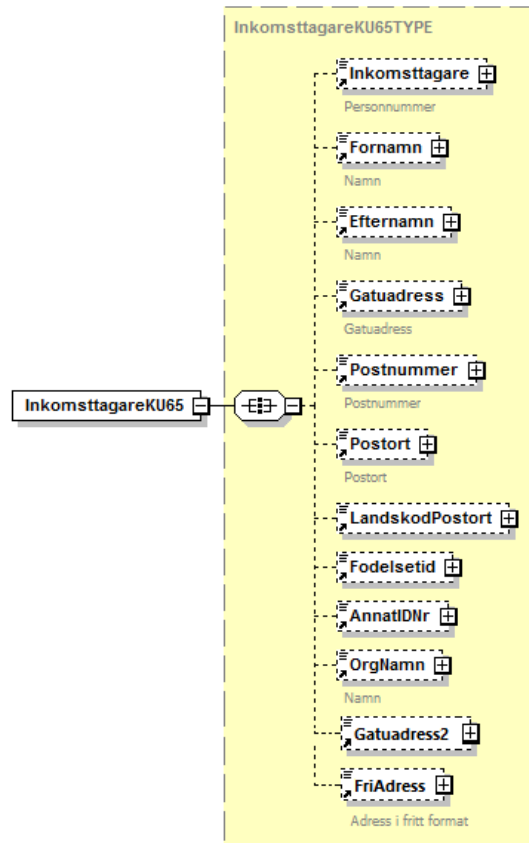

Term/Field		Element name in XML	No.	Type	Controls	
Description	Code				ID	Description
Personal identity number	215	Inkomsttagare	0-1	Identitet	056	Fk215 must exist if Fk222 and Fk224 are missing.

SKV 260 appendix 2	Version: 5.0
XML-struktur	2019-02-21

Term/Field Description	Code	Element name in XML	No.	Type	Controls	
					ID	Description
Person's first name	216	Fornamn	0-1	Text50	057, 142	FK216 must exist if FK215 and FK226 and FK222 exist and FK 205 is missing FK216 must exist if CCYY > 1800 and DD > 60 in FK215 and Fk205 is missing
Person's last name	217	Efternamn	0-1	Text50	058, 143	FK217 must exist if FK215 and FK226 FK222 exist and FK 205 is missing FK217 must exist if CCYY > 1800 and DD > 60 in FK215 and Fk205 is missing
Person's address	218	Gatuadress	0-1	Text50	059, 144, 152	FK218 must exist if FK222 exists and FK 205 and FK230 is missing FK218 must exist if CCYY > 1800 and DD > 60 in FK215 and Fk205 and FK230 is missing FK218 must exist if FK224 exists and FK205 and FK215 and FK222 and FK230 is missing
Person's address continuing	228	Gatuadress2	0-1	Text50		
Person's post number	219	Postnummer	0-1	PostNummer	060, 145, 153	FK219 must exist if FK222 exists and FK 205 and FK230 is missing FK219 must exist if CCYY > 1800 and DD > 60 in FK215 and Fk205 and FK230 is missing FK219 must exist if FK224 exists and FK205 and FK215 and FK222 and FK230 is missing
Person's postal location	220	Postort	0-1	Text50	061, 146, 154	FK220 must exist if FK222 exists and FK 205 and FK230 is missing FK220 must exist if CCYY > 1800 and DD > 60 in FK215 and Fk205 and FK230 is missing FK220 must exist if FK224 exists and FK205 and FK215 and FK222 and FK230 is missing
Country code for postal location	221	LandskodPostort	0-1	Landskod	166	FK221 must exist if FK230 exists
Date of birth	222	Fodelsetid	0-1	Fodelsetid	063	If FK215 exists, then FK222 must not exist
Other ID number for a legal entity	224	AnnatIDNr	0-1	Text20		
Name of legal entity	226	OrgNamn	0-1	Text50	065, 151	FK226 can not exist if Fk222 exists, if CC > 17 in FK215, if Fk216 exists or if Fk217 exists. FK226 must exist if FK224 exists and FK205 and FK215, FK216, FK217 and FK222 is missing

SKV 260 appendix 2	Version: 5.0
XML-struktur	2019-02-21

Term/Field Description	Code	Element name in XML	No.	Type	Controls	
					ID	Description
Address in free format	230	FriAdress	0-1	Text350		

6.2.24.2 Element: UppgiftslamnareKU65

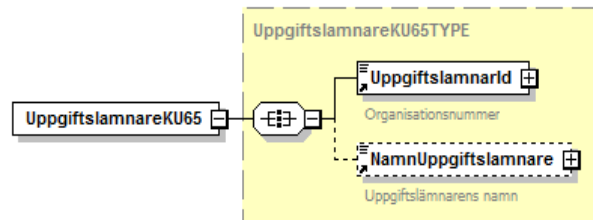

Term/Field Description	Code	Element name in XML	No.	Type	Controls	
					ID	Description
Information provider's organization number	201	UppgiftslamnarId	1	Identitet	053	FK201 can not be equal to FK215
Information provider's name	202	NamnUppgiftslamnare	0-1	Text50		

6.2.24.3 Changes compared to income year 2018 in KU65

Term/Field Description	Code	Element name in XML	No.	Type	Controls		Changes
					ID	Description	
New income statement							

SKV 260 appendix 2	Version: 5.0
XML-struktur	2019-02-21

6.2.25 KU66 – Renewable electricity

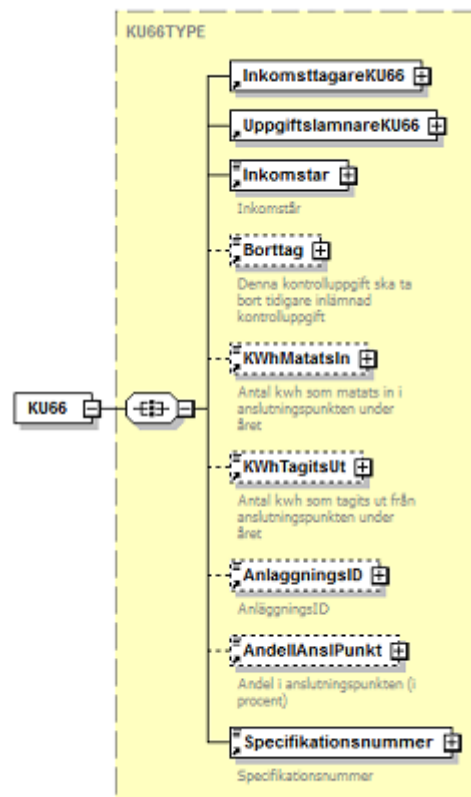

Term/Field Description	Code	Element name in XML	No.	Type	Controls	
					ID	Description
Period (year)	203	Inkomstar	1	Inkomstar		
Removal	205	Borttag	0-1	Kryss	055	FK205 can only exist if all codes but Fk201, Fk203, Fk570, Fk215, Fk222 and Fk224 are missing.
Number of kWh entered via the connection point during the year	270	KWhMatatsIn	0-1	KWh10	067	If FK205 is missing, Fk270 must exist.

SKV 260 appendix 2	Version: 5.0
XML-struktur	2019-02-21

Term/Field		Element name in XML	No.	Type	Controls	
Description	Code				ID	Description
Number of kWh used via the connection point during the year	271	KWhTagitsUt	0-1	KWh10	068	If FK205 is missing, Fk271 must exist.
Electrical installation ID	272	AnlaggningsID	0-1	AnIID	069	If FK205 is missing, Fk272 must exist.
Share in the connection point (in percent)	273	AndellAnsIPunkt	0-1	Decimal2		
Specification number	570	Specifikationsnummer	1	SpecifikationsNummer		
Income earner		InkomsttagareKU66	1	Grp		
Information provider		UppgiftslamnareKU66	1	Grp		

SKV 260 appendix 2	Version: 5.0
XML-struktur	2019-02-21

6.2.25.1 Element: *InkomsttagareKU66*

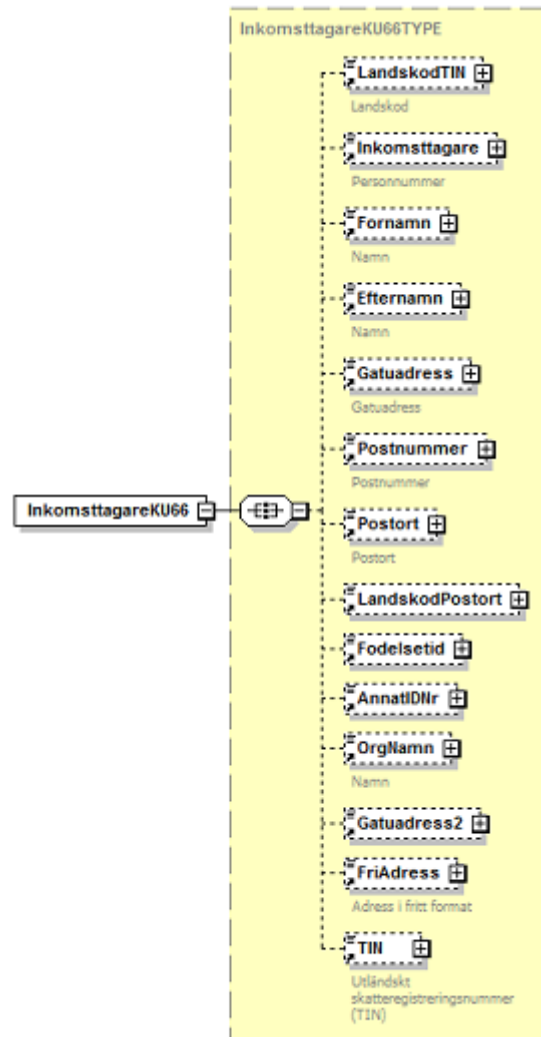

SKV 260 appendix 2	Version: 5.0
XML-struktur	2019-02-21

Term/Field Description	Code	Element name in XML	No.	Type	Controls	
					ID	Description
Country code for TIN	076	LandskodTIN	0-1	Landskod	045	FK076 must exist if FK252 exists.
Personal identity number	215	Inkomsttagare	0-1	Identitet	056	Fk215 must exist if Fk222 and Fk224 are missing.
Person's first name	216	Fornamn	0-1	Text50	057, 142	FK216 must exist if FK215 and FK226 and FK222 exist and FK 205 is missing FK216 must exist if CCYY > 1800 and DD > 60 in FK215 and Fk205 is missing
Person's last name	217	Efternamn	0-1	Text50	058, 143	FK217 must exist if FK215 and FK226 FK222 exist and FK 205 is missing FK217 must exist if CCYY > 1800 and DD > 60 in FK215 and Fk205 is missing
Person's address	218	Gatuadress	0-1	Text50	059, 144, 152	FK218 must exist if FK222 exists and FK 205 and FK230 is missing FK218 must exist if CCYY > 1800 and DD > 60 in FK215 and Fk205 and FK230 is missing FK218 must exist if FK224 exists and FK205 and FK215 and FK222 and FK230 is missing
Person's address continuing	228	Gatuadress2	0-1	Text50		
Person's post number	219	Postnummer	0-1	PostNummer	060, 145, 153	FK219 must exist if FK222 exists and FK 205 and FK230 is missing FK219 must exist if CCYY > 1800 and DD > 60 in FK215 and Fk205 and FK230 is missing FK219 must exist if FK224 exists and FK205 and FK215 and FK222 and FK230 is missing
Person's postal location	220	Postort	0-1	Text50	061, 146, 154	FK220 must exist if FK222 exists and FK 205 and FK230 is missing FK220 must exist if CCYY > 1800 and DD > 60 in FK215 and Fk205 and FK230 is missing FK220 must exist if FK224 exists and FK205 and FK215 and FK222 and FK230 is missing
Country code for postal location	221	LandskodPostort	0-1	Landskod	166	FK221 must exist if FK230 exists
Date of birth	222	Fodelsetid	0-1	Fodelsetid	063	If FK215 exists, then FK222 must not exist
Other ID number for a legal entity	224	AnnatIDNr	0-1	Text20		

SKV 260 appendix 2	Version: 5.0
XML-struktur	2019-02-21

Term/Field Description	Code	Element name in XML	No.	Type	Controls	
					ID	Description
Name of legal entity	226	OrgNamn	0-1	Text50	065, 151	FK226 can not exist if Fk222 exists, if CC > 17 in FK215, if Fk216 exists or if Fk217 exists. FK226 must exist if FK224 exists and FK205 and FK215, FK216, FK217 and FK222 is missing
Address in free format	230	FriAdress	0-1	Text350		
FOREIGN TAX IDENTIFICATION NUMBER (TIN).OTHER THAN SWEDISH.	252	TIN	0-1	Text20	066	FK252 must exist if FK076 exists

6.2.25.2 Element: UppgiftslamnareKU66

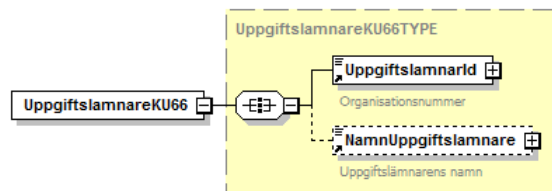

Term/Field Description	Code	Element name in XML	No.	Type	Controls	
					ID	Description
Information provider's organization number	201	UppgiftslamnarId	1	Identitet	053	FK201 can not be equal to FK215
Information provider's name	202	NamnUppgiftslamnare	0-1	Text50		

6.2.25.3 Changes compared to income year 2018 in KU66

Term/Field Description	Code	Element name in XML	No.	Type	Controls		Changes
					ID	Description	
No changes							

SKV 260 appendix 2	Version: 5.0
XML-struktur	2019-02-21

6.2.26 KU67 – Trade union dues

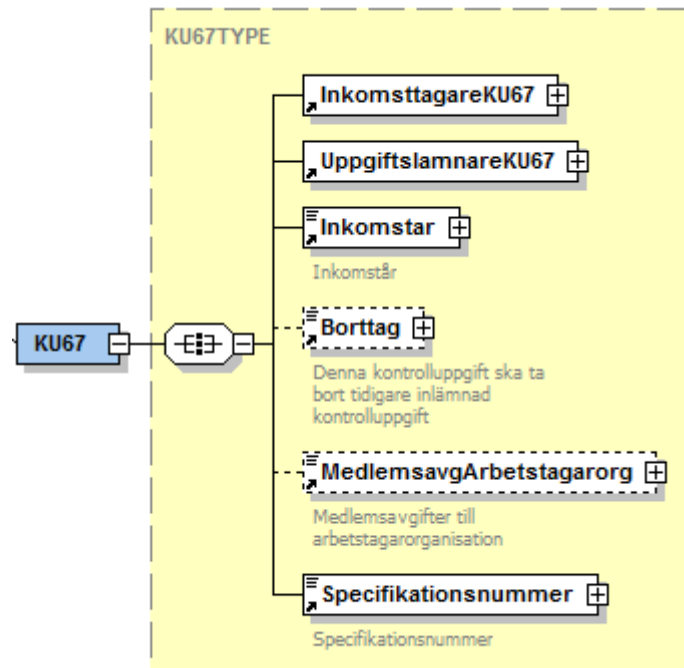

Term/Field Description	Code	Element name in XML	No.	Type	Controls	
					ID	Description
Period (year)	203	Inkomstar	1	Inkomstar		
Removal	205	Borttag	0-1	Kryss	055	FK205 can only exist if all codes but Fk201, Fk203, Fk570, Fk215, Fk222 and Fk224 are missing.
Trade union dues	550	MedlemsavgArbetstagarorg	0-1	Belopp6	182	If Fk205 is missing, Fk550 must exist.
Specification number	570	Specifikationsnummer	1	SpecifikationsNummer		
Income earner		InkomsttagareKU66	1	Grp		
Information provider		UppgiftslamnareKU66	1	Grp		

SKV 260 appendix 2	Version: 5.0
XML-struktur	2019-02-21

6.2.26.1 Element: *InkomsttagareKU67*

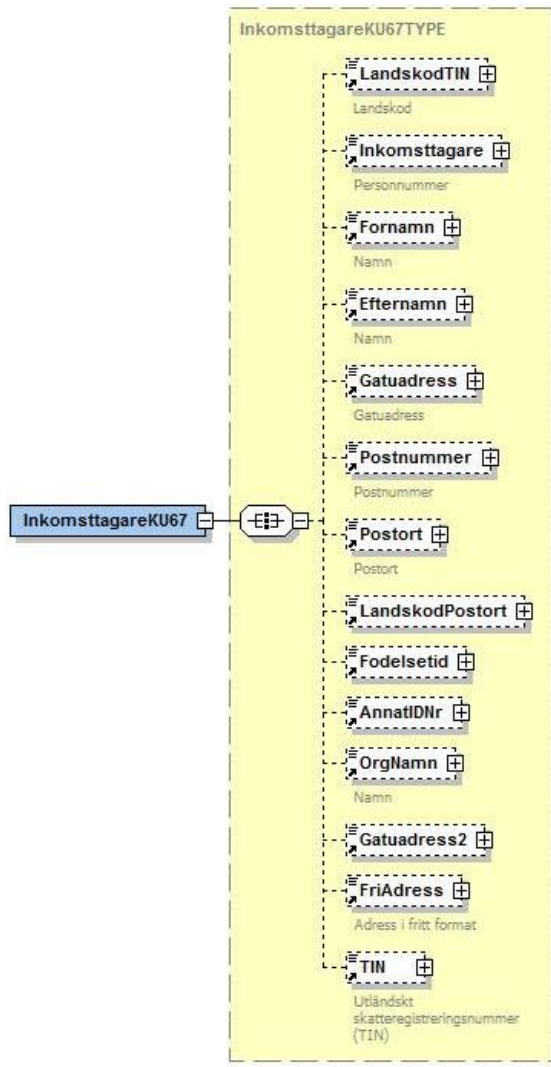

SKV 260 appendix 2	Version: 5.0
XML-struktur	2019-02-21

Term/Field		Element name in XML	No.	Type	Controls	
Description	Code				ID	Description
Country code for TIN	076	LandskodTIN	0-1	Landskod	045	FK076 must exist if FK252 exists.
Personal identity number	215	Inkomsttagare	0-1	Identitet	056	Fk215 must exist if Fk222 and Fk224 are missing.
Person's first name	216	Fornamn	0-1	Text50	057, 142	FK216 must exist if FK215 and FK226 and FK222 exist and FK 205 is missing FK216 must exist if CCYY > 1800 and DD > 60 in FK215 and Fk205 is missing
Person's last name	217	Efternamn	0-1	Text50	058, 143	FK217 must exist if FK215 and FK226 FK222 exist and FK 205 is missing FK217 must exist if CCYY > 1800 and DD > 60 in FK215 and Fk205 is missing
Person's address	218	Gatuadress	0-1	Text50	059, 144, 152	FK218 must exist if FK222 exists and FK 205 and FK230 is missing FK218 must exist if CCYY > 1800 and DD > 60 in FK215 and Fk205 and FK230 is missing FK218 must exist if FK224 exists and FK205 and FK215 and FK222 and FK230 is missing
Person's address continuing	228	Gatuadress2	0-1	Text50		
Person's post number	219	Postnummer	0-1	PostNummer	060, 145, 153	FK219 must exist if FK222 exists and FK 205 and FK230 is missing FK219 must exist if CCYY > 1800 and DD > 60 in FK215 and Fk205 and FK230 is missing FK219 must exist if FK224 exists and FK205 and FK215 and FK222 and FK230 is missing
Person's postal location	220	Postort	0-1	Text50	061, 146, 154	FK220 must exist if FK222 exists and FK 205 and FK230 is missing FK220 must exist if CCYY > 1800 and DD > 60 in FK215 and Fk205 and FK230 is missing FK220 must exist if FK224 exists and FK205 and FK215 and FK222 and FK230 is missing
Country code for postal location	221	LandskodPostort	0-1	Landskod	166	FK221 must exist if FK230 exists
Date of birth	222	Fodelsetid	0-1	Fodelsetid	063	If FK215 exists, then FK222 must not exist
Other ID number for a legal entity	224	AnnatIDNr	0-1	Text20		

SKV 260 appendix 2	Version: 5.0
XML-struktur	2019-02-21

Term/Field Description	Code	Element name in XML	No.	Type	Controls	
					ID	Description
Name of legal entity	226	OrgNamn	0-1	Text50	065, 151	FK226 can not exist if Fk222 exists, if CC > 17 in FK215, if Fk216 exists or if Fk217 exists. FK226 must exist if FK224 exists and FK205 and FK215, FK216, FK217 and FK222 is missing
Address in free format	230	FriAdress	0-1	Text350		
FOREIGN TAX IDENTIFICATION NUMBER (TIN).OTHER THAN SWEDISH.	252	TIN	0-1	Text20	066	FK252 must exist if FK076 exists

6.2.26.2 Element: UppgiftslamnareKU67

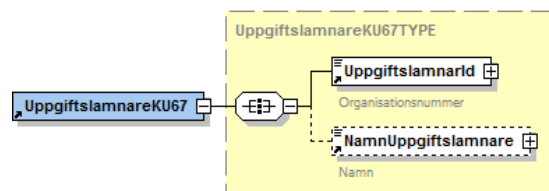

Term/Field Description	Code	Element name in XML	No.	Type	Controls	
					ID	Description
Information provider's organization number	201	UppgiftslamnarId	1	Identitet	053	FK201 can not be equal to FK215
Information provider's name	202	NamnUppgiftslamnare	0-1	Text50		

6.2.26.3 Changes compared to income year 2018 in KU67

Term/Fält Beskrivning	Kod	Elementnamn i XML	Ant	Typ	Fältkontroller		Förändring
					ID	Beskrivning	
No changes							

SKV 260 appendix 2	Version: 5.0
XML-struktur	2019-02-21

6.2.27 KU70 – Income statement regarding operating subsidies and royalties

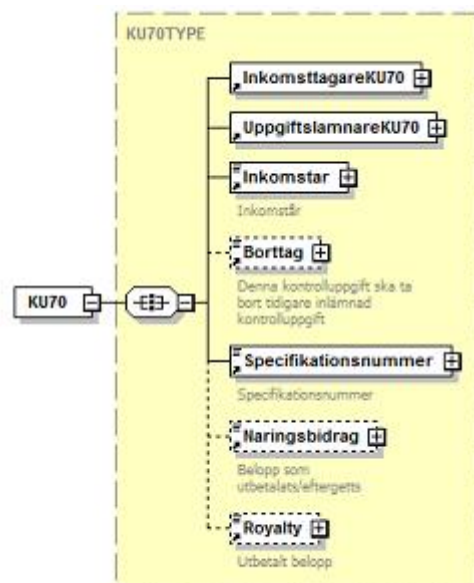

Term/Field	Code	Element name in XML	No.	Type	Controls	
					ID	Description
Income year	203	Inkomstar	1	Inkomstar		
Removal	205	Borttag	0-1	Kryss	055	Fk205 can only exist if all codes but Fk201, Fk203, Fk570, Fk215, Fk222 and Fk224 are missing.
Specification number	570	Specifikationsnummer	1	Specifikationsnummer		
Sums paid/remitted	716	Naringsbidrag	0-1	Belopp10	118	Fk716 can not exist if Fk717 exists.
Royalty	717	Royalty	0-1	Belopp10	119	Fk717 must exist if FK205 and Fk716 are missing
Income earner		InkomsttagareKU70	1	Grp		
Information provider		UppgiftslamnareKU70	1	Grp		

SKV 260 appendix 2	Version: 5.0
XML-struktur	2019-02-21

6.2.27.1 Element: *InkomsttagareKU70*

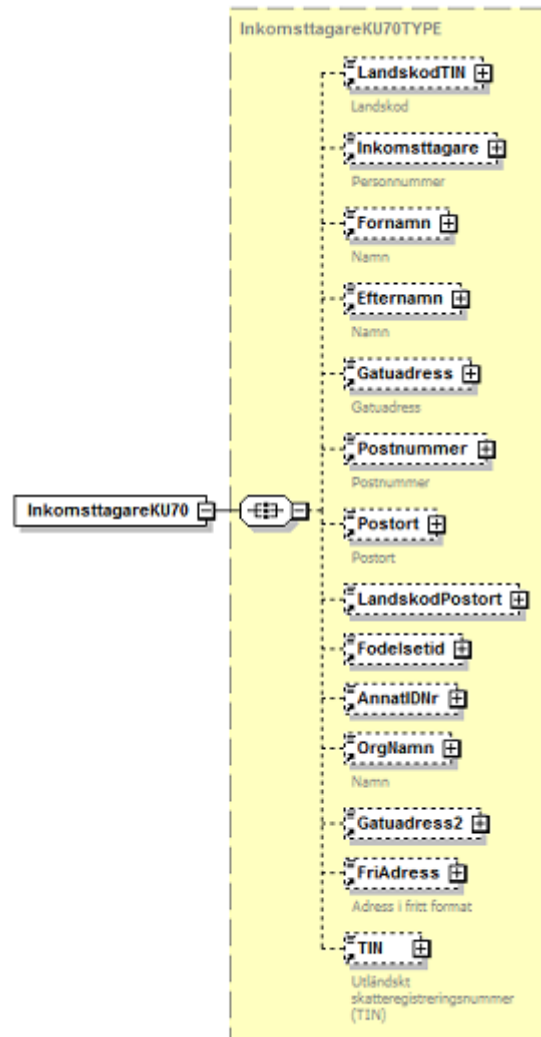

SKV 260 appendix 2	Version: 5.0
XML-struktur	2019-02-21

Term/Field Description	Code	Element name in XML	No.	Type	Controls	
					ID	Description
Country code for TIN	076	LandskodTIN	0-1	Landskod	045	FK076 must exist if FK252 exists.
Personal identity number	215	Inkomsttagare	0-1	Identitet	056	Fk215 must exist if Fk222 and Fk224 are missing.
Person's first name	216	Fornamn	0-1	Text50	057, 142	FK216 must exist if FK222 exists and FK 205 is missing FK216 must exist if FK215 has the value CCYY > 1800 and DD > 60 and Fk205 is missing
Person's last name	217	Efternamn	0-1	Text50	058, 143	FK217 must exist if FK222 exists and FK 205 is missing FK217 must exist if FK215 has the value CCYY > 1800 and DD > 60 and Fk205 is missing
Person's address	218	Gatuadress	0-1	Text50	059, 144, 152	FK218 must exist if FK222 exists and FK 205 and FK230 is missing FK218 must exist if CCYY > 1800 and DD > 60 in FK215 and Fk205 and FK230 is missing FK218 must exist if FK224 exists and FK205 and FK215 and FK222 and FK230 is missing
Person's address continuing	228	Gatuadress2	0-1	Text50		
Person's post number	219	Postnummer	0-1	PostNummer	060, 145, 153	FK219 must exist if FK222 exists and FK 205 and FK230 is missing FK219 must exist if CCYY > 1800 and DD > 60 in FK215 and Fk205 and FK230 is missing FK219 must exist if FK224 exists and FK205 and FK215 and FK222 and FK230 is missing
Person's postal location	220	Postort	0-1	Text50	061, 146, 154	FK220 must exist if FK222 exists and FK 205 and FK230 is missing FK220 must exist if CCYY > 1800 and DD > 60 in FK215 and Fk205 and FK230 is missing FK220 must exist if FK224 exists and FK205 and FK215 and FK222 and FK230 is missing
Country code for postal location	221	LandskodPostort	0-1	Landskod	166	FK221 must exist if FK230 exists
Date of birth	222	Fodelsetid	0-1	Fodelsetid	063	FK222 can not exist if FK215 exists
Other ID number for a legal entity	224	AnnatIDNr	0-1	Text20		

SKV 260 appendix 2	Version: 5.0
XML-struktur	2019-02-21

Term/Field Description	Code	Element name in XML	No.	Type	Controls	
					ID	Description
Name of legal entity	226	OrgNamn	0-1	Text50	065, 151	FK226 can not exist if Fk222 exists, if CC > 17 in FK215, if Fk216 exists or if Fk217 exists. FK226 must exist if FK224 exists and FK205 and FK215, FK216, FK217 and FK222 is missing
Address in free format	230	FriAdress	0-1	Text350		
Foreign tax identification number (TIN). Other than Swedish	252	TIN	0-1	Text20	066	FK252 must exist if FK076 exists

6.2.27.2 Element: UppgiftslamnareKU70

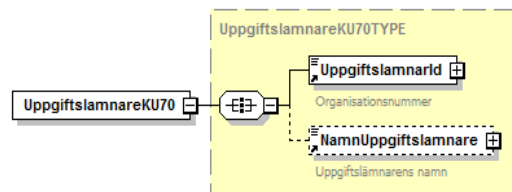

Term/Field Description	Code	Element name in XML	No.	Type	Controls	
					ID	Description
Information provider's organization number	201	UppgiftslamnarId	1	Identitet	053	FK201 can not be equal to FK215
Information provider's name	202	NamnUppgiftslamnare	0-1	Text50		

6.2.27.3 Changes compared to income year 2018 in KU70

Term/Field Description	Code	Element name in XML	No.	Type	Controls		Changes
					ID	Description	
No changes							

SKV 260 appendix 2	Version: 5.0
XML-struktur	2019-02-21

6.2.28 KU71 – Income statement regardig withdrawal from forest account, etc.

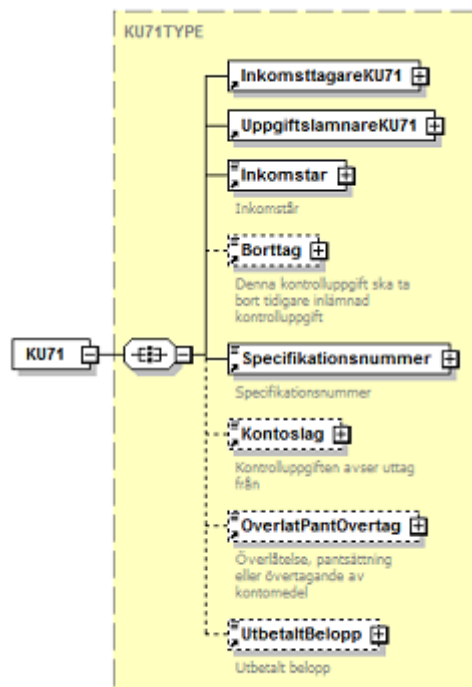

Term/Field Description	Code	Element name in XML	No.	Type	Controls	
					ID	Description
Income year	203	Inkomstar	1	Inkomstar		
Removal	205	Borttag	0-1	Kryss	055	FK205 can only exist if all codes but Fk201, Fk203, Fk570, Fk215, Fk222 and Fk224 are missing.
Specification number	570	Specifikationsnummer	1	SpecifikationsNummer		
Account type	740	Kontoslag	0-1	Kontoslag	124	Fk740 must exist if FK205 is missing
Transferring, pledging or taking over funds	743	OverlatPantOvertag	0-1	Kryss		

SKV 260 appendix 2	Version: 5.0
XML-struktur	2019-02-21

Term/Field		Element name in XML	No.	Type	Controls	
Description	Code				ID	Description
Paid amount	744	UtbetaltBelopp	0-1	Belopp10	125	Fk744 must exist if FK205 is missing.
Income earner		InkomsttagareKU71	1	Grp		
Information provider		UppgiftslamnareKU71	1	Grp		

SKV 260 appendix 2	Version: 5.0
XML-struktur	2019-02-21

6.2.28.1 Element: *InkomsttagareKU71*

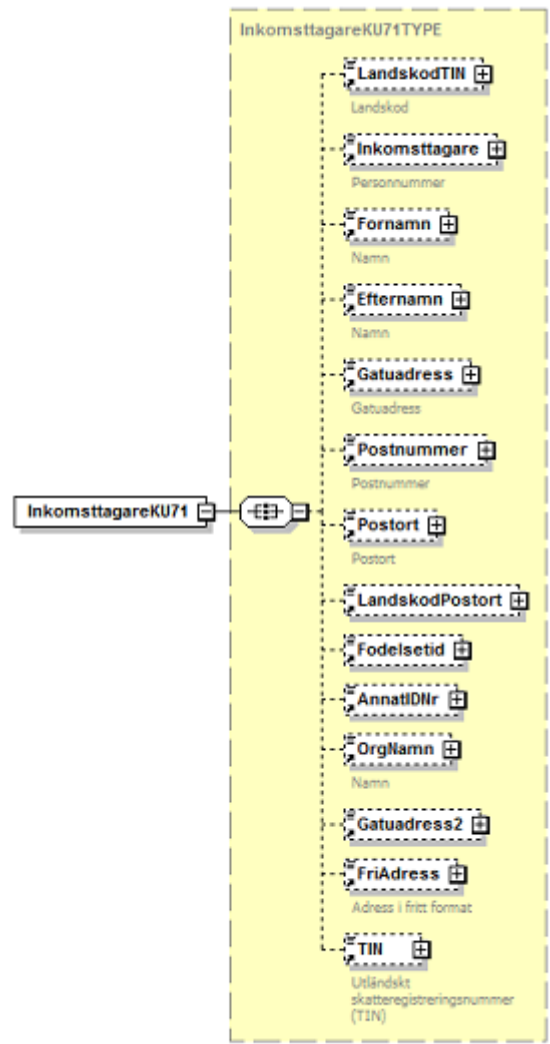

SKV 260 appendix 2	Version: 5.0
XML-struktur	2019-02-21

Term/Field Description	Code	Element name in XML	No.	Type	Controls	
					ID	Description
Country code for TIN	076	LandskodTIN	0-1	Landskod	045	FK076 must exist if FK252 exists.
Personal identity number	215	Inkomsttagare	0-1	Identitet	056	Fk215 must exist if Fk222 and Fk224 are missing.
Person's first name	216	Fornamn	0-1	Text50	057, 142	FK216 must exist if FK222 exists and FK 205 is missing FK216 must exist if FK215 has the value CCYY > 1800 and DD > 60 and Fk205 is missing
Person's last name	217	Efternamn	0-1	Text50	058, 143	FK217 must exist if FK222 exists and FK 205 is missing FK217 must exist if FK215 has the value CCYY > 1800 and DD > 60 and Fk205 is missing
Person's address	218	Gatuadress	0-1	Text50	059, 144, 152	FK218 must exist if FK222 exists and FK 205 and FK230 is missing FK218 must exist if CCYY > 1800 and DD > 60 in FK215 and Fk205 and FK230 is missing FK218 must exist if FK224 exists and FK205 and FK215 and FK222 and FK230 is missing
Person's address continuing	228	Gatuadress2	0-1	Text50		
Person's post number	219	Postnummer	0-1	PostNummer	060, 145, 153	FK219 must exist if FK222 exists and FK 205 and FK230 is missing FK219 must exist if CCYY > 1800 and DD > 60 in FK215 and Fk205 and FK230 is missing FK219 must exist if FK224 exists and FK205 and FK215 and FK222 and FK230 is missing
Person's postal location	220	Postort	0-1	Text50	061, 146, 154	FK220 must exist if FK222 exists and FK 205 and FK230 is missing FK220 must exist if CCYY > 1800 and DD > 60 in FK215 and Fk205 and FK230 is missing FK220 must exist if FK224 exists and FK205 and FK215 and FK222 and FK230 is missing
Country code for postal location	221	LandskodPostort	0-1	Landskod	166	FK221 must exist if FK230 exists
Date of birth	222	Fodelsetid	0-1	Fodelsetid	063	FK222 can not exist if FK215 exists
Other ID number for a legal entity	224	AnnatIDNr	0-1	Text20		

SKV 260 appendix 2	Version: 5.0
XML-struktur	2019-02-21

Term/Field Description	Code	Element name in XML	No.	Type	Controls	
					ID	Description
Name of legal entity	226	OrgNamn	0-1	Text50	065, 151	FK226 can not exist if Fk222 exists, if CC > 17 in FK215, if Fk216 exists or if Fk217 exists. FK226 must exist if FK224 exists and FK205 and FK215, FK216, FK217 and FK222 is missing
Address in free format	230	FriAdress	0-1	Text350		
Foreign tax identification number (TIN). Other than Swedish	252	TIN	0-1	Text20	066	FK252 must exist if FK076 exists

6.2.28.2 Element: UppgiftslamnareKU71

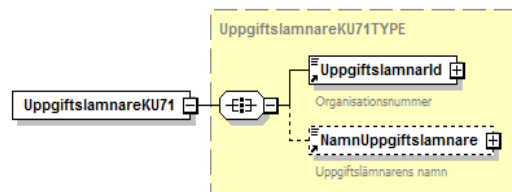

Term/Field Description	Code	Element name in XML	No.	Type	Controls	
					ID	Description
Information provider's organization number	201	UppgiftslamnarId	1	Identitet	053	FK201 can not be equal to FK215
Information provider's name	202	NamnUppgiftslamnare	0-1	Text50		

6.2.28.3 Changes compared to income year 2018 in KU71

Term/Field Description	Code	Element name in XML	No.	Type	Controls		Changes
					ID	Description	
No changes							

SKV 260 appendix 2	Version: 5.0
XML-struktur	2019-02-21

6.2.29 KU72 – Income statement regarding deposit in forest account, etc.

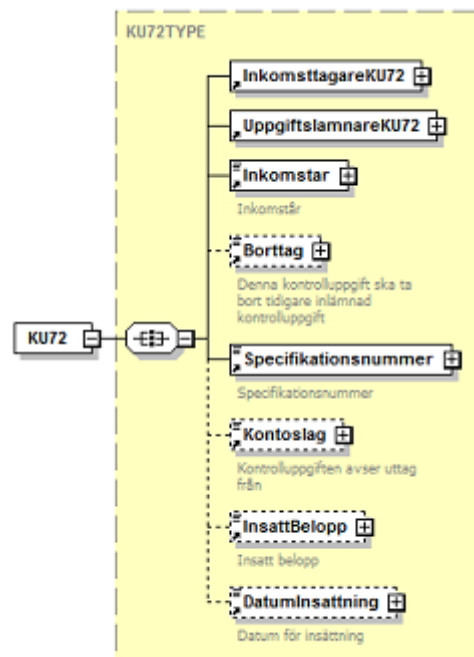

Term/Field					Controls	
Description	Code	Element name in XML	No.	Type	ID	Description
Income year	203	Inkomstar	1	Inkomstar		
Removal	205	Borttag	0-1	Kryss	055	FK205 can only exist if all codes but Fk201, Fk203, Fk570, Fk215, Fk222 and Fk224 are missing.
Specification number	570	Specifikationsnummer	1	SpecifikationsNummer		
Account type	740	Kontoslag	0-1	Kontoslag	124	Fk740 must exist if FK205 is missing
Deposited amount	745	InsattBelopp	0-1	Belopp10	141	Fk745 must exist if FK205 is missing

SKV 260 appendix 2	Version: 5.0
XML-struktur	2019-02-21

Term/Field		Element name in XML	No.	Type	Controls	
Description	Code				ID	Description
Date of deposit	746	DatumInsatning	0-1	Datum	126, 127	Fk746 must exist if FK205 is missing YYYY in FK746 = FK203 or (YYYY in FK746 = FK203+1 and MMDD < 0701)
Income earner		InkomsttagareKU72	1	Grp		
Information provider		UppgiftslamnareKU72	1	Grp		

SKV 260 appendix 2	Version: 5.0
XML-struktur	2019-02-21

6.2.29.1 Element: *InkomsttagareKU72*

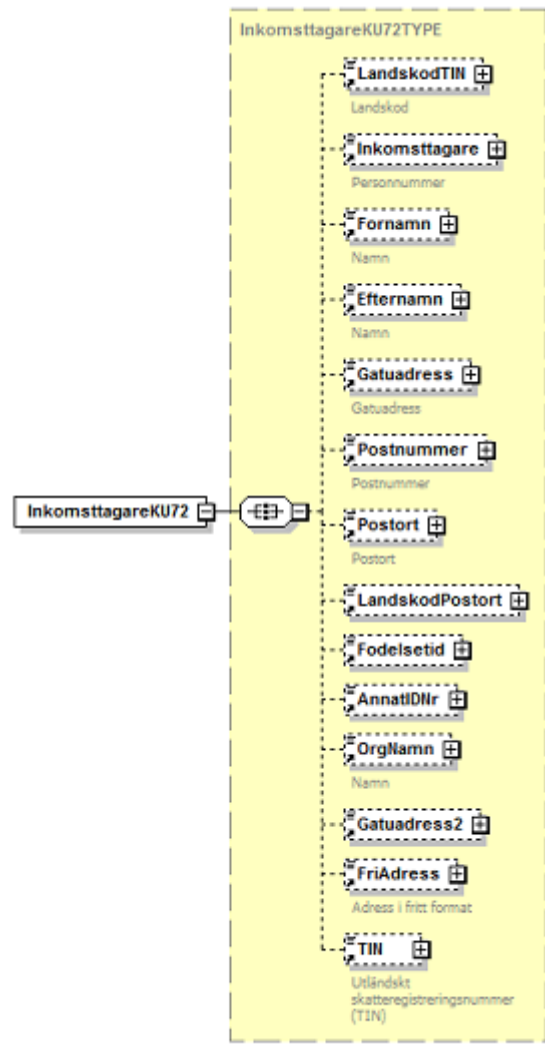

SKV 260 appendix 2	Version: 5.0
XML-struktur	2019-02-21

Term/Field Description	Code	Element name in XML	No.	Type	Controls	
					ID	Description
Country code for TIN	076	LandskodTIN	0-1	Landskod	045	FK076 must exist if FK252 exists.
Personal identity number	215	Inkomsttagare	0-1	Identitet	056	Fk215 must exist if Fk222 and Fk224 are missing.
Person's first name	216	Fornamn	0-1	Text50	057, 142	FK216 must exist if FK222 exists and FK 205 is missing FK216 must exist if FK215 has the value CCYY > 1800 and DD > 60 and Fk205 is missing
Person's last name	217	Efternamn	0-1	Text50	058, 143	FK217 must exist if FK222 exists and FK 205 is missing FK217 must exist if FK215 has the value CCYY > 1800 and DD > 60 and Fk205 is missing
Person's address	218	Gatuadress	0-1	Text50	059, 144, 152	FK218 must exist if FK222 exists and FK 205 and FK230 is missing FK218 must exist if CCYY > 1800 and DD > 60 in FK215 and Fk205 and FK230 is missing FK218 must exist if FK224 exists and FK205 and FK215 and FK222 and FK230 is missing
Person's address continuing	228	Gatuadress2	0-1	Text50		
Person's post number	219	Postnummer	0-1	PostNummer	060, 145, 153	FK219 must exist if FK222 exists and FK 205 and FK230 is missing FK219 must exist if CCYY > 1800 and DD > 60 in FK215 and Fk205 and FK230 is missing FK219 must exist if FK224 exists and FK205 and FK215 and FK222 and FK230 is missing
Person's postal location	220	Postort	0-1	Text50	061, 146, 154	FK220 must exist if FK222 exists and FK 205 and FK230 is missing FK220 must exist if CCYY > 1800 and DD > 60 in FK215 and Fk205 and FK230 is missing FK220 must exist if FK224 exists and FK205 and FK215 and FK222 and FK230 is missing
Country code for postal location	221	LandskodPostort	0-1	Landskod	166	FK221 must exist if FK230 exists
Date of birth	222	Fodelsetid	0-1	Fodelsetid	063	FK222 can not exist if FK215 exists
Other ID number for a legal entity	224	AnnatIDNr	0-1	Text20		

SKV 260 appendix 2	Version: 5.0
XML-struktur	2019-02-21

Term/Field Description	Code	Element name in XML	No.	Type	Controls	
					ID	Description
Name of legal entity	226	OrgNamn	0-1	Text50	065, 151	FK226 can not exist if Fk222 exists, if CC > 17 in FK215, if Fk216 exists or if Fk217 exists. FK226 must exist if FK224 exists and FK205 and FK215, FK216, FK217 and FK222 is missing
Address in free format	230	FriAdress	0-1	Text350		
FOREIGN TAX IDENTIFICATION NUMBER (TIN).OTHER THAN SWEDISH.	252	TIN	0-1	Text20	066	FK252 must exist if FK076 exists

6.2.29.2 Element: UppgiftslamnareKU72

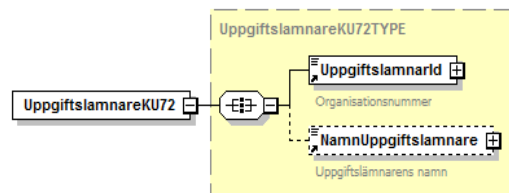

Term/Field Description	Code	Element name in XML	No.	Type	Controls	
					ID	Description
Information provider's organization number	201	UppgiftslamnarId	1	Identitet	053	FK201 can not be equal to FK215
Information provider's name	202	NamnUppgiftslamnare	0-1	Text50		

SKV 260 appendix 2	Version: 5.0
XML-struktur	2019-02-21

6.2.29.3 Changes compared to income year 2018 in KU72

Term/Field Description	Code	Element name in XML	No.	Type	Controls		Changes
					ID	Description	
No changes							

SKV 260 appendix 2	Version: 5.0
XML-struktur	2019-02-21

6.2.30 KU73 – Income statement regarding dividends etc. for share-holders in an association

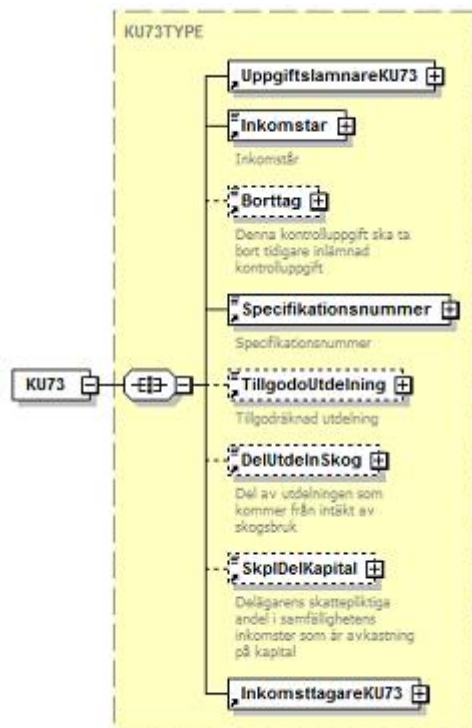

Term/Field					Controls	
Description	Code	Element name in XML	No.	Type	ID	Description
Income year	203	Inkomstar	1	Inkomstar		
Removal	205	Borttag	0-1	Kryss	055	FK205 can only exist if all codes but Fk201, Fk203, Fk570, Fk215, Fk222 and Fk224 are missing.
Specification number	570	Specifikationsnummer	1	SpecifikationsNummer		
The above-mentioned share-holders have been credited dividends with	730	TillgodoUtdelning	0-1	Belopp10	120	Fk730 must exist if FK205 and FK732 are missing.

SKV 260 appendix 2	Version: 5.0
XML-struktur	2019-02-21

Term/Field		Element name in XML	No.	Type	Controls	
Description	Code				ID	Description
Share of the dividends that come from forestry revenue	731	DelUtdeInSkog	0-1	Belopp10	121, 122	FK731 can not exist if FK732 exists. FK731 can not be > FK730
The share-holder's taxable share in the association's income which is yield on capital	732	SkplDelKapital	0-1	Belopp10	123	Fk732 can not exist if Fk730 exists.
Income earner		InkomsttagareKU73	1	Grp		
Information provider		UppgiftslamnareKU73	1	Grp		

SKV 260 appendix 2	Version: 5.0
XML-struktur	2019-02-21

6.2.30.1 Element: *InkomsttagareKU73*

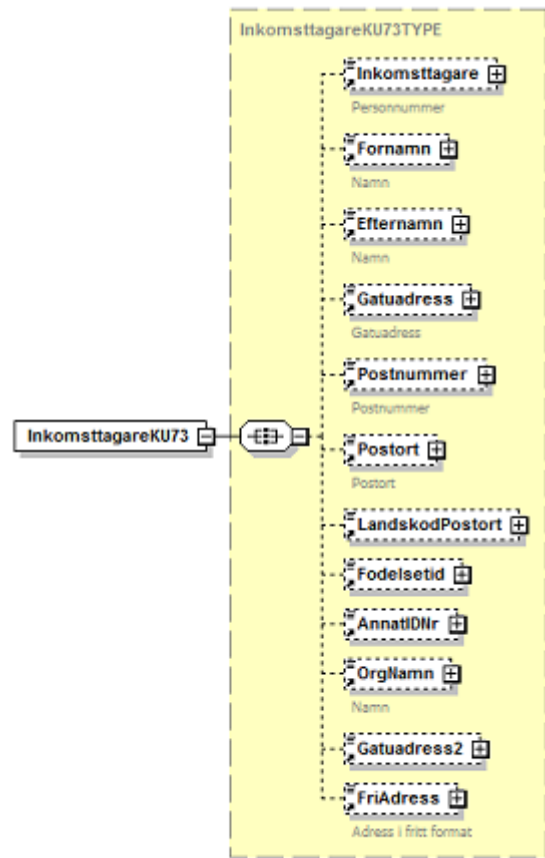

SKV 260 appendix 2	Version: 5.0
XML-struktur	2019-02-21

Term/Field Description	Code	Element name in XML	No.	Type	Controls	
					ID	Description
Personal identity number	215	Inkomsttagare	0-1	Identitet	056	Fk215 must exist if Fk222 and Fk224 are missing.
Person's first name	216	Fornamn	0-1	Text50	057, 142	FK216 must exist if FK222 exists and FK 205 is missing FK216 must exist if FK215 has the value CCYY > 1800 and DD > 60 and Fk205 is missing
Person's last name	217	Efternamn	0-1	Text50	058, 143	FK217 must exist if FK222 exists and FK 205 is missing FK217 must exist if FK215 has the value CCYY > 1800 and DD > 60 and Fk205 is missing
Person's address	218	Gatuadress	0-1	Text50	059, 144, 152	FK218 must exist if FK222 exists and FK 205 and FK230 is missing FK218 must exist if CCYY > 1800 and DD > 60 in FK215 and Fk205 and FK230 is missing FK218 must exist if FK224 exists and FK205 and FK215 and FK222 and FK230 is missing
Person's address continuing	228	Gatuadress2	0-1	Text50		
Person's post number	219	Postnummer	0-1	PostNummer	060, 145, 153	FK219 must exist if FK222 exists and FK 205 and FK230 is missing FK219 must exist if CCYY > 1800 and DD > 60 in FK215 and Fk205 and FK230 is missing FK219 must exist if FK224 exists and FK205 and FK215 and FK222 and FK230 is missing
Person's postal location	220	Postort	0-1	Text50	061, 146, 154	FK220 must exist if FK222 exists and FK 205 and FK230 is missing FK220 must exist if CCYY > 1800 and DD > 60 in FK215 and Fk205 and FK230 is missing FK220 must exist if FK224 exists and FK205 and FK215 and FK222 and FK230 is missing
Country code for postal location	221	LandskodPostort	0-1	Landskod	166	FK221 must exist if FK230 exists
Date of birth	222	Fodelsetid	0-1	Fodelsetid	063	FK222 can not exist if FK215 exists
Other ID number for a legal entity	224	AnnatIDNr	0-1	Text20		
Name of legal entity	226	OrgNamn	0-1	Text50	065, 151	FK226 can not exist if Fk222 exists, if CC > 17 in FK215, if Fk216 exists or if Fk217 exists. FK226 must exist if FK224 exists and FK205 and FK215, FK216, FK217 and FK222 is missing

SKV 260 appendix 2	Version: 5.0
XML-struktur	2019-02-21

Term/Field Description	Code	Element name in XML	No.	Type	Controls	
					ID	Description
Address in free format	230	FriAdress	0-1	Text350		

6.2.30.2 Element: UppgiftslamnareKU73

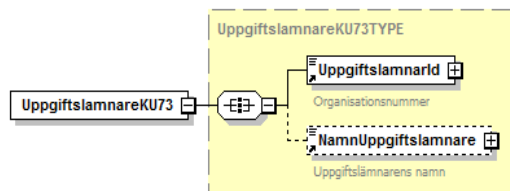

Term/Field Description	Code	Element name in XML	No.	Type	Controls	
					ID	Description
Information provider's organization number	201	UppgiftslamnarId	1	Identitet	053	FK201 can not be equal to FK215
Information provider's name	202	NamnUppgiftslamnare	0-1	Text50		

6.2.30.3 Changes compared to income year 2018 in KU73

Term/Field Description	Code	Element name in XML	No.	Type	Controls		Changes
					ID	Description	
No changes							

SKV 260 appendix 2	Version: 5.0
XML-struktur	2019-02-21

6.2.31 KU80 – Income statement regarding foreign payments to Sweden

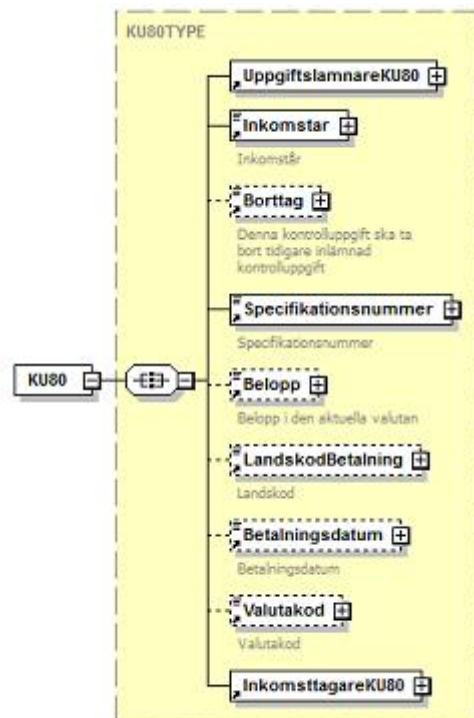

Term/Field Description	Code	Element name in XML	No.	Type	Controls	
					ID	Description
Income year	203	Inkomstar	1	Inkomstar		
Removal	205	Borttag	0-1	Kryss	055	FK205 can only exist if all codes but Fk201, Fk203, Fk570, Fk215, Fk222 and Fk224 are missing.
Specification number	570	Specifikationsnummer	1	SpecifikationsNummer		
Amounts in the currency in question	660	Belopp	0-1	Belopp12	109	Fk660 must exist if FK205 is missing
Country code	662	LandskodBetaling	0-1	Landskod	111	Fk662 must exist if FK205 is missing

SKV 260 appendix 2	Version: 5.0
XML-struktur	2019-02-21

Term/Field Description	Code	Element name in XML	No.	Type	Controls	
					ID	Description
Payment date	663	Betalningsdatum	0-1	Datum	112, 138	Fk663 must exist if FK205 is missing YYYY in Fk663 must be = Fk203
Currency code	664	Valutakod	0-1	Valutakod	113	Fk664 must exist if FK205 is missing
Income earner		InkomsttagareKU80	1	Grp		
Information provider		UppgiftslamnareKU80	1	Grp		

6.2.31.1 Element: InkomsttagareKU80

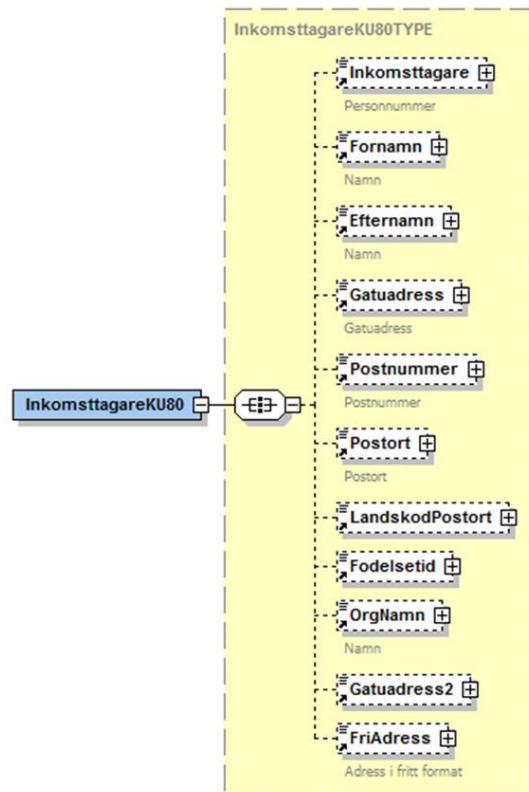

SKV 260 appendix 2	Version: 5.0
XML-struktur	2019-02-21

Term/Field Description	Code	Element name in XML	No.	Type	Controls	
					ID	Description
Personal identity number	215	Inkomsttagare	0-1	Identitet	181	FK215 must exist if FK222 is missing
Person's first name	216	Fornamn	0-1	Text50	142	FK216 must exist if CCYY > 1800 and DD > 60 in FK215 and Fk205 is missing
Person's last name	217	Efternamn	0-1	Text50	143	FK217 must exist if CCYY > 1800 and DD > 60 in FK215 and Fk205 is missing
Person's address	218	Gatuadress	0-1	Text50	144	FK218 must exist if CCYY > 1800 and DD > 60 in FK215 and Fk205 and Fk230 is missing
Person's address continuing	228	Gatuadress2	0-1	Text50		
Person's post number	219	Postnummer	0-1	PostNummer	145	FK219 must exist if CCYY > 1800 and DD > 60 in FK215 and Fk205 and FK230 is missing
Person's postal location	220	Postort	0-1	Text50	146	FK220 must exist if CCYY > 1800 and DD > 60 in FK215 and Fk205 and FK230 is missing
Country code for postal location	221	LandskodPostort	0-1	Landskod	166	FK221 must exist if FK230 exists
Date of birth	222	Fodelsetid	0-1	Fodelsetid	063	FK222 cannot exist if FK215 exists
Name of legal entity	226	OrgNamn	0-1	Text50	065	FK226 cannot exist if Fk222 exists, if CC > 17 in FK215, if Fk216 exists or if Fk217 exists.
Address in free format	230	FriAdress	0-1	Text350		

6.2.31.2 Element: UppgiftslamnareKU80

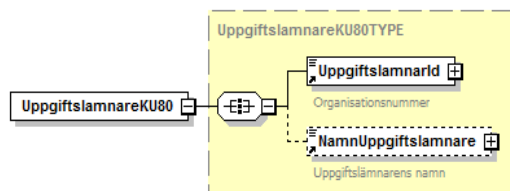

SKV 260 appendix 2	Version: 5.0
XML-struktur	2019-02-21

Term/Field		Element name in XML	No.	Type	Controls	
Description	Code				ID	Description
Information provider's organization number	201	UppgiftslamnarId	1	Identitet		
Information provider's name	202	NamnUppgiftslamnare	0-1	Text50		

6.2.31.3 Changes compared to income year 2018 in KU80

Term/Field		Element name in XML	No.	Type	Controls		Changes
Description	Code				ID	Description	
No changes							

SKV 260 appendix 2	Version: 5.0
XML-struktur	2019-02-21

6.2.32 KU81 – Income statement regarding foreign payments from Sweden

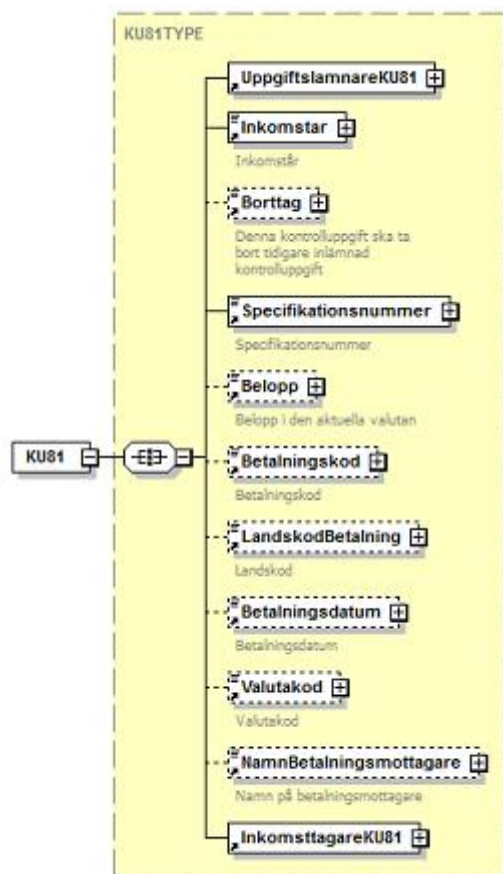

Term/Field Description	Code	Element name in XML	No.	Type	Controls	
					ID	Description
Income year	203	Inkomstar	1	Inkomstar		
Removal	205	Borttag	0-1	Kryss	055	FK205 can only exist if all codes but Fk201, Fk203, Fk570, Fk215, Fk222 and Fk224 are missing.

SKV 260 appendix 2	Version: 5.0
XML-struktur	2019-02-21

Term/Field Description	Code	Element name in XML	No.	Type	Controls	
					ID	Description
Specification number	570	Specifikationsnummer	1	SpecifikationsNummer		
Amounts in the currency in question	660	Belopp	0-1	Belopp12	109	Fk660 must exist if FK205 is missing
Payment code	661	Betalningskod	0-1	Betalkod	110	Fk661 must exist if FK205 is missing
Country code	662	LandskodBetaling	0-1	Landskod	111	Fk662 must exist if FK205 is missing
Payment date	663	Betalningsdatum	0-1	Datum	112, 138	Fk663 must exist if FK205 is missing YYYY i Fk663 must be = Fk203
Currency code	664	Valutakod	0-1	Valutakod	113	Fk664 must exist if FK205 is missing
Name of payee	671	NamnBetalningsmottagare	0-1	Text36	114	Fk671 must exist if FK205 is missing
Income earner		InkomsttagareKU81	1	Grp		
Information provider		UppgiftslamnareKU81	1	Grp		

SKV 260 appendix 2	Version: 5.0
XML-struktur	2019-02-21

6.2.32.1 Element: InkomstagareKU81

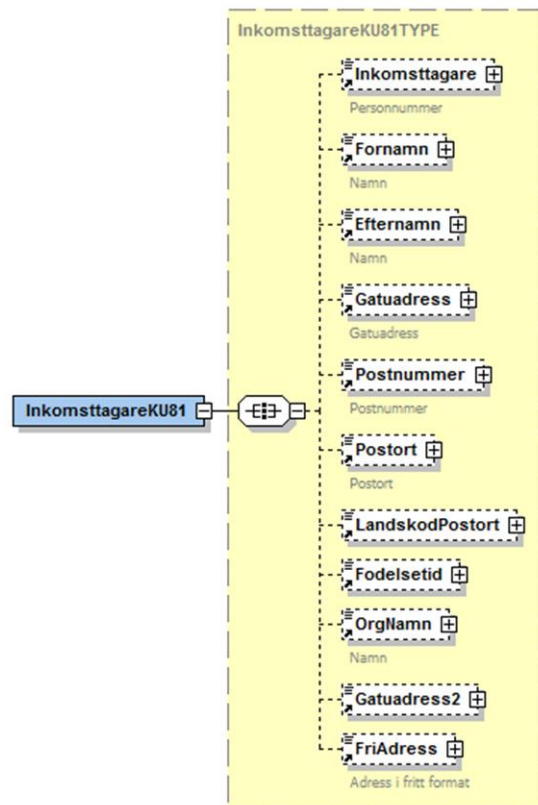

Term/Field					Controls	
Description	Code	Element name in XML	No.	Type	ID	Description
Personal identity number	215	Inkomstagare	0-1	Identitet	181	FK215 must exist if FK222 is missing
Person's first name	216	Fornamn	0-1	Text50	142	FK216 must exist if CCYY > 1800 and DD > 60 in FK215 and Fk205 is missing
Person's last name	217	Efternamn	0-1	Text50	143	FK217 must exist if CCYY > 1800 and DD > 60 in FK215 and Fk205 is missing

SKV 260 appendix 2	Version: 5.0
XML-struktur	2019-02-21

Term/Field Description	Code	Element name in XML	No.	Type	Controls	
					ID	Description
Person's address	218	Gatuadress	0-1	Text50	144	FK218 must exist if CCYY > 1800 and DD > 60 in FK215 and Fk205 is missing and FK230 is missing
Person's address continuing	228	Gatuadress2	0-1	Text50		
Person's post number	219	Postnummer	0-1	PostNummer	145	FK219 must exist if CCYY > 1800 and DD > 60 in FK215 and Fk205 is missing and FK230 is missing
Person's postal location	220	Postort	0-1	Text50	146	FK220 must exist if CCYY > 1800 and DD > 60 in FK215 and Fk205 is missing and FK230 is missing
Country code for postal location	221	LandskodPostort	0-1	Landskod	166	FK221 must exist if FK230 exists
Date of birth	222	Fodelsetid	0-1	Fodelsetid	063	FK222 cannot exist if FK215 exists
Name of legal entity	226	OrgNamn	0-1	Text50	065	FK226 can not exist if Fk222 exists, if CC > 17 in FK215, if Fk216 exists or if Fk217 exists.
Address in free format	230	FriAdress	0-1	Text350		

6.2.32.2 Element: UppgiftslamnareKU81

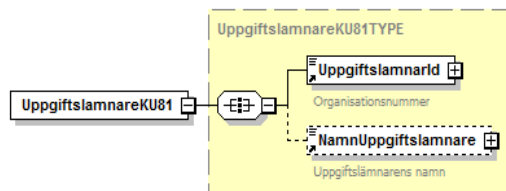

Term/Field Description	Kod	Element name in XML	No.	Type	Controls	
					ID	Description
Information provider's organization number	201	UppgiftslamnarId	1	Identitet		
Information provider's name	202	NamnUppgiftslamnare	0-1	Text50		

SKV 260 appendix 2	Version: 5.0
XML-struktur	2019-02-21

6.2.32.3 Changes compared to income year 2018 in KU81

Term/Field			No.	Type	Controls		Changes
Description	Code	Element name in XML			ID	Description	
No changes							

SKV 260 appendix 2	Version: 5.0
XML-struktur	2019-02-21

6.2.33 KupongS – Accounting, Swedish withholding tax in VPC-registered/-affiliated companies

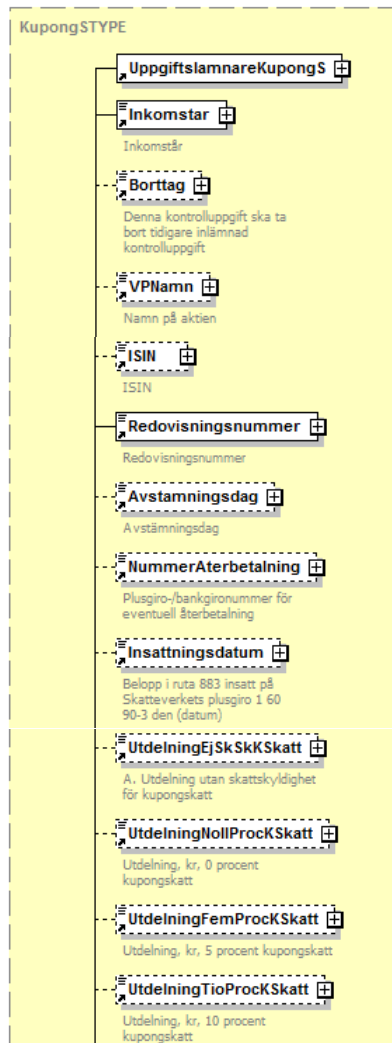



SKV 260 appendix 2	Version: 5.0
XML-struktur	2019-02-21



Term/Field		Element name in XML	No.	Type	Controls	
Description	Code				ID	Description
Income year	203	Inkomstar	1	Inkomstar		
Removal	205	Borttag	0-1	Kryss	161	Fk 205 can only exist if all codes but Fk201, Fk203, Fk572, Fk851, and Fk890 are missing.
The fund's title	571	VPNamn	0-1	Text50		
ISIN	572	ISIN	0-1	Isin	165	Exatly one of codes Fk572 or Fk890 must exist.
Merchant number	851	Redovisningsnummer	1	Text10		
Record date	853	Avstamningsdag	0-1	Datum		
Postal or bank giro account that should be used for repayments	854	NummerAterbetalning	0-1	Text 13		
Payment day	855	Insattningsdatum	0-1	Datum		
A. Dividend without tax liability on Swedish withholding tax	860	UtdelningEjSkSkKSkatt	0-1	BeloppNeg12	171	FK860 must exist if FK205 is missing
Dividends, SEK, 0 percent Swedish withholding tax	861	UtdelningNollProckSkatt	0-1	BeloppNeg12		
Dividends, SEK, 5 percent Swedish withholding tax	862	UtdelningFemProckSkatt	0-1	BeloppNeg12		
Dividends, SEK, 10 percent Swedish withholding tax	863	UtdelningTioProckSkatt	0-1	BeloppNeg12		

SKV 260 appendix 2	Version: 5.0
XML-struktur	2019-02-21

Term/Field Description	Code	Element name in XML	No.	Type	Controls	
					ID	Description
Dividends, SEK, 15 percent Swedish withholding tax	864	UtdelningFemtonProcKSkatt	0-1	BeloppNeg12		
Dividends, SEK, 20 percent Swedish withholding tax	865	UtdelningTjugoProcKSkatt	0-1	BeloppNeg12		
Dividends, SEK, 25 percent Swedish withholding tax	866	UtdelningTjugofemProcKSkatt	0-1	BeloppNeg12		
Dividends, SEK, 30 percent Swedish withholding tax	867	UtdelningTrettioProcKSkatt	0-1	BeloppNeg12		
Dividends, Sum A and B	869	SaUtdelningAB	0-1	BeloppNeg12		
5 percent Swedish withholding tax	872	KSkattFemProc	0-1	BeloppNeg12		
10 percent Swedish withholding tax	873	KSkattTioProc	0-1	BeloppNeg12		
15 percent Swedish withholding tax	874	KSkattFemtonProc	0-1	BeloppNeg12		
20 percent Swedish withholding tax	875	KSkattTjugoProc	0-1	BeloppNeg12		
25 percent Swedish withholding tax	876	KSkattTjugofemProc	0-1	BeloppNeg12		
30 percent Swedish withholding tax	877	KSkattTrettioProc	0-1	BeloppNeg12		
Swedish withholding tax, Sum A and B	879	SaKSkattAB	0-1	BeloppNeg12		
Total amount of dividends previously reported for the income year	881	SaTidigareRedUtdelning	0-1	Belopp12		
Dividends, SEK, SUM TOTAL	882	TotalsummaUtdelning	0-1	BeloppNeg12		
Swedish withholding tax, SEK, SUM TOTAL	883	TotalsummaKSkatt	0-1	BeloppNeg12		
Remuneration received from Euroclear	884	UtdFranEuroclear	0-1	Belopp12		
Organisation number for company paying dividend	890	OrgnrUtdelandeBolag	0-1	Identitet		
Information provider		UppgiftslamnareKupongS	1	Grp		

SKV 260 appendix 2	Version: 5.0
XML-struktur	2019-02-21

6.2.33.1 UppgiftslamnareKupongS

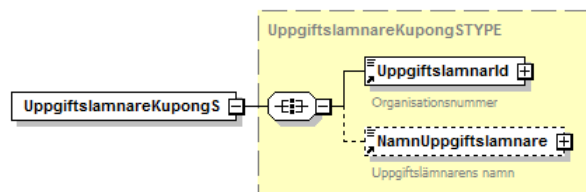

Term/Field		Element name in XML	No.	Type	Controls	
Description	Code				ID	Description
Information provider's organization number	201	UppgiftslamnarId	1	Identitet		
Information provider's name	202	NamnUppgiftslamnare	0-1	Text50		

6.2.33.2 Changes compared to income year 2018 in KupongS

Term/Field		Element name in XML	No.	Type	Controls		Changes
Description	Code				ID	Description	
No changes							

SKV 260 appendix 2	Version: 5.0
XML-struktur	2019-02-21

7 Attributes

This chapter describes the attributes that should be applied to certain elements in the income statement file.

7.1 Attribute "omrade" in element "Skatteverket"

The attribute is compulsory and should be set to "Kontrolluppgifter".

7.2 Attribute "nummer" in element "Blankett"

The attribute is compulsory and should be the SKV number of the income statement form specified in the element "Blankettinnehall". The following table shows the connection between number and form.

Swedish income statements:

SKV-number	Form, Description
2300	KU10 – Income statement from employers etc.
2340	KU13 – Income statement – Special income tax for non-residents (SINK)
2303	KU14 – Special income statement – Pensionable income and exchange of income statements
2306	KU16 – Income statement regarding maritime income etc.
2307	KU17 – Special income statement – special income tax (for non-residents, sink) for foreign residents with maritime income
2310	KU18 – Income statement – Pension- and insurance payers and others
2341	KU19 – Income statement – Pension- and insurance payers and others – Special income tax for non-residents (SINK)
2323	KU20 – Income statement – Interest income
2320	KU21 – Income statement for bonds
2336	KU25 – Income statement for interest expense
2337	KU26 – Income statement for site leasehold fees
2335	KU28 – Income statement for investment deductions
2312	KU30 – Income statement for investment savings account – standard income
2322	KU31 – Income statement for dividends etc for shares and other securities
2318	KU32 – Income statement for transfer of shares, bonds and other securities
2315	KU34 – Income statement for the transfer/issuance/completion of options
2325	KU35 – Kontrolluppgift – Income statement for completion of futures
2339	KU40 – Kontrolluppgift – Income statement for transfer of shares in investment funds
2313	KU41 – Income statement – Investment fund – standard income
2338	KU50 – Income statement for pension savings

SKV 260 appendix 2	Version: 5.0
XML-struktur	2019-02-21

2327	KU52 – Income statement for foreign insurance
2351	KU53 – Income statement regarding indirect insurance
2324	KU55 – Income statement regarding transfer of tenant-ownership in a housing association
2314	KU65 – Income statement donation
2350	KU66 – Income statement regarding renewable electricity
2326	KU67 – Income statement regarding trade unit dues
2316	KU70 – Income statement regarding operating subsidies and royalties
2319	KU71 – Income statement regarding withdrawal from forest account, etc.
2321	KU72 – Income statement regarding deposit in forest account, etc.
2317	KU73 – Income statement regarding dividends etc. for share-holders in an association
2329	KU80 – Income statement regarding foreign payments to Sweden
2328	KU81 – Income statement regarding foreign payments from Sweden
3715	KupongS - Accounting, Swedish withholding tax in VPC-registered/-affiliated companies

7.3 Attribute “faltkod” in various data elements

The attribute “faltkod” is compulsory and fixed and should be set to the field code in the corresponding income statement form.

The following table shows the connection between field code and form field that can occur in electronic income statements.

Fältkod (FK)	Fältnamn, blankett	Elementnamn, XML
001	Tax deducted	AvdragenSkatt
002	Foreign tax deducted	AvdragenUtlandskSkatt
003	Swedish withholding tax on dividend	AvdragenKupongskatt
004	Remuneration code. See table for remuneration code on website	Ersättningskod
005	Amount in the current currency	ErsättningBelopp
011	Cash gross income etc.	KontantBruttolonMm
012	Taxable benefits excl.employer-provided car and free fuel in connection with employer-provided car	FormanUtomBilDrivmedel
013	Taxable benefit of employer-provided car exclusive of fuel	BilformanUtomDrivmedel
018	Free fuel in connection with employer-provided car	DrivmedelVidBilforman
020	Compensation for expenses not filled in the boxes 050 - 056	AndraKostnadsers
021	Basis for tax reduction for household services	UnderlagRutarbete
022	Basis for tax reduction for "ROT-work"	UnderlagRotarbete

SKV 260 appendix 2	Version: 5.0
XML-struktur	2019-02-21

025	Remuneration for which the employee pays social security contributions	ErsMEgenavgifter
026	Vessel signal	Fartygssignal
027	Number of days	AntalDagarSjoinkomst
028	Short sea shipping/Long haul	NarfartFjarrfart
030	Occupational pension	Tjanstepension
031	Remunerations for which social security contributions are not paid	ErsEjSocAvg
032	Remunerations for which social security contributions are not paid and which are not entitled to special job deduction	ErsEjSocAvgEjJobbavd
035	Not taxable remunerations to foreign key persons according to decision from the Swedish Forskarskattenämnden	Forskarskattenamnden
036	Compensation for benefit of housing and travels to and from employment/board meetings	ErsFormanBostadMmSINK
037	Certain deductions	VissaAvdrag
039	Rent	Hysesersattning
041	Free housing 1- or 2-family house	BostadSmahus
043	Free housing other than code 41	BostadEjSmahus
048	Benefit has been adjusted	FormanHarJusterats
049	Benefit as pension	FormanSomPension
050	Car allowance	Bilersattning
051	Per diem	Traktamente
059	Employee options that are not subject to preferential taxation have been utilized for acquisition of shares	PersonaloptionForvarvAndel
060	Number for work location	Arbetsstallnummer
061	Partner	Delagare
075	Country code for foreign organization number	LandskodUL
076	Country code for TIN	LandskodTIN
077	Birthplace	Fodelseort
078	Country code for birthplace	LandskodFodelseort
079	Code for country of residence	LandskodHemvist
081	Country code for citizenship	LandskodMedborgare
090	Country code for country where work is performed	LandskodArbetsland
091	Time for work abroad	UtsandUnderTid
092	Mark one of A-F	Kategori
093	Social security agreement exists	SocialAvgiftsAvtal

SKV 260 appendix 2	Version: 5.0
XML-struktur	2019-02-21

201	Reporting agent's organization number	UppgiftslamnarId
202	Reporting agent's name	NamnUppgiftslamnare
203	Income year	Inkomstar
205	Removal	Borttag
215	Personal identity number	Inkomsttagare
216	Person's first name	Fornamn
217	Person's last name	Efternamn
218	Person's address	Gatuadress
219	Person's post number	Postnummer
220	Person's postal location	Postort
221	Country code for postal location	LandskodPostort
222	Date of birth	Fodelsetid
223	Name of vessel	FartygetsNamn
224	Other ID number for a legal entity	AnnatIDNr
226	Name of legal entity	OrgNamn
228	Person's address continuing	Gatuadress2
230	Address in free format	FriAdress
251	Workplace country	Arbetsland
252	Foreign tax identification number (TIN). Other than Swedish.	TIN
270	Number of kWh entered via the connection point during the year	KWhMatatsIn
271	Number of kWh used via the connection point during the year	KWhTagitsUt
272	Electrical installation ID	AnlaggningsID
273	Share in the connection point (in percent)	AndellAnslPunkt
500	Interest income, account	Ranteinkomst
502	Disposition account (more than five)	Forfogarkonto
503	Interest income, not account	RanteinkomstEjKonto
504	Other income	AnnanInkomst
506	Information provider's foreign organization number	ULUtlandsktOrgnr
507	Insurance agreement number	Forsakringsavtalsnummer
520	Total interest, legality of claim	RantaFordringsratter

SKV 260 appendix 2	Version: 5.0
XML-struktur	2019-02-21

522	Paid amount in some cases	UtbetallVissaFall
523	Deposit number	Depanummer
524	Share of the deposit	AndelAvDepan
525	Received interest compensation	ErhallenRantekompensation
528	Basis for Investors Deduction	UnderlagForInvesteraravdrag
529	Total Basis for Investors Deduction	TotUnderlagInvesteraravdrag
530	Payment year	Betalningsar
531	Reversal due to sale	AterforingAvyttring
532	Reversal due to moving abroad	AterforingUtflyttning
533	Reversal due to too high distribution	AterforingHogVardeoverforing
534	Reversal due to certain internal acquisitions	AterforingInternaForvarv
540	Paid and deductible interest for the year	AvdragsgillRanta
541	Total paid interest (stated only if an advanced interest is paid that is not deductible for the year)	TotalInbetaldRanta
543	Paid interest compensation	BetaldRantekompensation
544	Joint loan for more than five persons where the lender cannot say who all the persons are	GemensamtLan
550	Trade union dues	MedlemsavgArbetstagarorg
560	Paid site leasehold fee	BetaldTomtrattsavgald
561	Property designation	Fastighetsbeteckning
570	Specification number	Specifikationsnummer
571	The fund's title	VPNamn
572	ISIN	ISIN
573	Transferred to investment savings account	AvyttradTillISK
574	Paid dividend	UtbetaldUtdelning
576	Number transferred (Sold or redeemed)	AntalAvytrade
578	Number of contracts	AntalKontrakt
581	Other received compensation taxable for Swedish withholding tax	AnnanKupongErsattning
599	Interest/Dividend/Compensation with unknown value	OkandVarde
600	Capital gain	Kapitalvinst
601	Capital loss	Kapitalforlust
602	The fund has not been listed on the market	FondInteMarknadsnoterad

SKV 260 appendix 2	Version: 5.0
XML-struktur	2019-02-21

606	Bond fund	Rantefond
620	Paid premium in applicable currency	BetaldPremie
621	Received donation amount	MottagetGavobelopp
630	The cooperative property/flat's identification	BostRattBeteckning
631	Date of transfer	Overlatelsedatum
632	Transferred part	OverlatenAndel
633	Type of transfer	OverlatelseArvBodeln
634	Transfer price	Overlatelsepris
635	Transferred reparation funds	InreRepFondOverlatelse
636	Added capital	Kapitaltillskott
638	The housing association is a housing association covered by the Companies Act (not a private housing association)	OaktaBostadsftg
639	Additional purchase sum	Tillaggsopeskilling
640	Date of acquisition (YYYYMMDD)	Forvarvsdatum
642	Type of acquisition	ForvarvArvBodeln
643	Purchase price	Forvarvspris
644	Acquired reparation funds	InreRepFondForvarv
645	Share from 1st of January 1974	AndelBRFFormogenhet1974
646	Individual or common information	GemensamIndividuell
652	Value at end of previous year	Kapitalunderlag
654	Type of insurance, see definitions	TypForsakring
660	Amounts in the currency in question	Belopp
661	Payment code	Betalningskod
662	Country code	LandskodBetaling
663	Payment date	Betalningsdatum
664	Currency code	Valutakod
671	Name of payee	NamnBetalningsmottagare
680	Foreign insurer's name	NamnForsakrGivare
681	Foreign insurer's address	AdrForsakrGivare
682	Foreign insurer's postal location	PostadrForsakrGivare
683	Foreign insurer's registration number	SvensktRegNr

SKV 260 appendix 2	Version: 5.0
XML-struktur	2019-02-21

716	Sums paid/remitted	Naringsbidrag
717	Royalty	Royalty
730	The above-mentioned share-holders have been credited dividends with	TillgodoUtdelning
731	Share of the dividends that come from forestry revenue	DelUtdelnSkog
732	The share-holder's taxable share in the association's income which is yield on capital	SkpIDelKapital
740	Account type	Kontoslag
743	Transferring, pledging or taking over funds	OverlatPantOvertag
744	Paid amount	UtbetaltBelopp
745	Deposited amount	InsattBelopp
746	Date of deposit	DatumInsattning
810	Received compensation	ErhallenErsattning
811	Paid compensation	ErlagdErsattning
812	Type of option	TypAvOption
813	Maturity	OptionenForfallen
814	Gross/Net	Redovisningsmetod
815	Standard income	Schablonintakt
817	Number of account	Kontonummer
851	Merchant number	Redovisningsnummer
853	Record date	Avstamningsdag
854	Postal or bank giro account that should be used for repayments	NummerAterbetalning
855	The amount in 883 payed to the Skatteverket postal giro account number 1 60 90-3 (date)	Insattningsdatum
860	A. Dividend without tax liability on Swedish withholding tax	UtdelningEjSkSkKSkatt
861	Dividends, SEK, 0 percent Swedish withholding tax	UtdelningNollProckSkatt
862	Dividends, SEK, 5 percent Swedish withholding tax	UtdelningFemProckSkatt
863	Dividends, SEK, 10 percent Swedish withholding tax	UtdelningTioProckSkatt
864	Dividends, SEK, 15 percent Swedish withholding tax	UtdelningFemtonProckSkatt
865	Dividends, SEK, 20 percent Swedish withholding tax	UtdelningTjugoProckSkatt
866	Dividends, SEK, 25 percent Swedish withholding tax	UtdelningTjugofemProckSkatt
867	Dividends, SEK, 30 percent Swedish withholding tax	UtdelningTrettioProckSkatt
869	Dividends, Sum A and B	SaUtdelningAB

SKV 260 appendix 2	Version: 5.0
XML-struktur	2019-02-21

872	5 percent Swedish withholding tax	KSkattFemProc
873	10 percent Swedish withholding tax	KSkattTioProc
874	15 percent Swedish withholding tax	KSkattFemtonProc
875	20 percent Swedish withholding tax	KSkattTjugoProc
876	25 percent Swedish withholding tax	KSkattTjugofemProc
877	30 percent Swedish withholding tax	KSkattTrettioProc
879	Swedish withholding tax, Sum A and B	SaKSkattAB
881	Total amount of dividends previously reported for the income year	SaTidigareRedUtdelning
882	Dividends, SEK, SUM TOTAL	TotalsummaUtdelning
883	Swedish withholding tax, SEK, SUM TOTAL	TotalsummaKSkatt
884	Remuneration received from Euroclear	UtdFranEuroclear
890	Organisation number for company paying dividend	OrgnrUtdelandeBolag